

Modeling Chemical Reaction Kinetics

Preview

In previous chapters of this text, we have considered various forms of energy, however, we treated them mostly in isolation. Transitions between different forms of energy were accomplished by so-called energy transducers, but, until now, never more than two forms of energy were involved in any such transition. Chapter 8 has shed some light on distributed processes, and has shown how one form of energy, namely heat, is transported by and transmitted through matter. In this chapter, we shall discuss what happens to the total energy balance when one type of matter interacts with another, i.e., we shall look at the thermodynamics of chemical reaction systems. Notice that, in this analysis, we are not so much interested in the chemical properties of matter (such as color, taste, smell, or toxicity), as we are interested in the physical properties of matter (such as temperature, pressure, volume, flow rate, or concentration). In this discussion, it will be unavoidable to consider a multitude of simultaneously occurring energy transitions.

9.1 Introduction

We have seen that all physical systems require two different types of variables for a complete description of their dynamics. In an electrical circuit, we cannot usually write state equations in terms of voltages or currents alone, but, in any circuit which contains both capacitors and inductors, we always need a combination of the two. This is due to the fact that, in a capacitor, voltage is integrated, while, in an inductor, current is integrated.

In Chapter 8, we saw that thermodynamic systems can be described by either temperature or heat alone, i.e., the state equations can be described either in terms of temperatures or in terms of heat only. This is due to the fact that no thermal inertia exists. Any system that contains only one type of storage element can be described in terms of one type of state variables. The thermodynamic literature exploits this fact frequently. It was shown, however, that this simplification has a very unwelcome side effect. If we concentrate on one form of state variable (such as the temperature), we lose the capability of balancing the energy (power) correctly, and therefore, it becomes very difficult to connect the thermal subsystem to other subsystems. In other words, as long as we are happy to analyze a thermal system in isolation, we can concentrate on temperatures alone, but, if we wish to connect the thermal system to other systems, we must carry along both types of adjugate variables, i.e., temperatures and entropy flows.

Table 7.1 shows that also chemical systems do not possess inertia. The two adjugate variables, the *chemical potential* μ and the *molar flow* ν can therefore be decoupled. It is possible to describe the dynamics of a chemical reaction in terms of *number of moles* and *molar flow rates* alone without consideration of the chemical potential. Since chemical reactions are highly non-linear, we can't express the number of moles in terms of molar flow rates, and the resulting differential equations will thus use the number of moles as state variables rather than the molar flow rates. Frequently, the number of moles are furthermore normalised with the reactor volume, resulting in a set of differential equations using *molar densities/concentrations* as state variables.

The literature on *chemical reaction kinetics* operates traditionally on molar concentrations and their time derivatives exclusively, and it ignores the energy and its conservation entirely [9.7]. Many of these references do not even introduce the chemical potential as a system property at all.

On the other hand, the literature on *chemical thermodynamics* concentrates on the overall energy balance in a chemical reaction using terms such as the *enthalpy*, the *entropy* (differently defined than in Chapter 8), and the *Gibbs free energy* [9.13]. Some of these references introduce the chemical potential as an auxiliary quantity that can be derived from the Gibbs free energy, others don't [9.9]. However, all of these references discuss the *equilibrium state thermodynamics* only, i.e., they ignore the dynamic behavior of the system. Therefore, flow rates are of no concern to them.

As in the case of the thermal systems, the disadvantage of this dichotomy is the fact that it prevents us from connecting a chemical reaction system dynamically with other subsystems. As long as we are happy to analyze chemical reaction systems in isolation, the decomposition into the *dynamic* reaction kinetics and the *static* thermodynamics may be quite appropriate. However, if we wish to analyze dynamically the interaction between chemical, thermic, pneumatic, mechanical, and electric subsystems, this approach becomes inadequate. It is the goal of this chapter to derive a methodology that will enable us to describe the dynamic behavior of chemical reaction systems through a set of adjugate variables, and thereby, enable us to study the dynamic interactions of chemical reaction systems with their environment.

9.2 Chemical Reaction Kinetics

The physics behind chemical reactions among gases or aqueous solutions are very similar to those discussed in Chapter 8. As in thermodynamics, we can distinguish between *macroscopic* and *microscopic* aspects of such reactions. As in the previous chapter, we shall mostly concentrate on the macroscopic aspects, but we need some understanding of the microscopic aspects in order to derive the correct macroscopic equations.

Let us look at the chemical reaction:

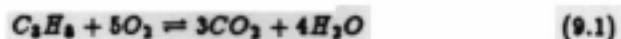

By convention, the chemical species on the left hand side of the arrow are called the *reactants*, while the species to the right of the arrow are called *products*. However, the two-sided arrow indicates that, in reality, two different reactions take place. Eq(9.1) is an abbreviation for the reaction system:

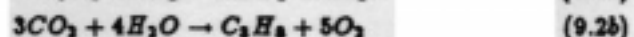
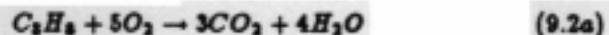

The first reaction states that when one molecule of propane C_3H_8 meets with five molecules of oxygen O_2 , the atoms may regroup and form seven new molecules, namely three molecules of carbon dioxide

CO_2 and four molecules of water vapor H_2O . The second reaction states that the reverse may also happen.

Any chemical reaction describes a trade of atoms between a number of different molecules. In this trade, the mass balance must be preserved, i.e., the number of atoms of each type on both sides of the arrow must be the same, and an integer number of molecules is involved in the trade. The act of balancing the masses in a chemical reaction is called *stoichiometry*, and the integer constants that multiply each species (i.e., the number of molecules involved in the trade) are called the *stoichiometric coefficients*. The mass balance is achieved by ensuring that the total number of atoms of each type is equal on both sides of the arrow.

It is interesting to discuss how frequently such a trade occurs. For this purpose, we need to look at the microscopic aspects of the chemical reaction. In order for the trade to take place, all the involved partner molecules must meet at the same time at one place. Let us assume that the molecules are mixed in a completely homogeneous manner. Consequently, the probability of any one molecule to be at any one place is the same. In other words, the probability of a molecule to be in any unit volume element of the mixture is the same and is proportional to the concentration of the molecule in the overall mixture (solution). We can furthermore assume that the probability of any one molecule to be in a considered unit volume element is *statistically independent* from the probability of any other molecule to be in the same unit volume element. Thus, the joint probability of all partner molecules to be in the same unit volume element at the same time is proportional to the product of their concentrations.

Let us denote the concentration of a molecule M by c_M . For example, we shall denote the concentration of water vapor as c_{H_2O} . Therefore, the reaction according to eq(9.2a) should occur with a reaction rate of:

$$k_1 \cdot c_{C_2H_6} \cdot c_{O_2}^3 \quad (9.3a)$$

and similarly, for the second reaction:

$$k_2 \cdot c_{CO_2}^3 \cdot c_{H_2O}^4 \quad (9.3b)$$

We denote this by placing the reaction rate constants on the arrows:

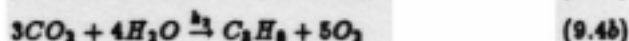
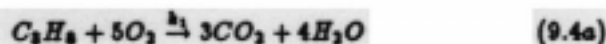

and thus, we are made believe that we can write the following set of differential equations for the reaction system:

$$\frac{d}{dt}c_{C_2H_2} = k_2 \cdot c_{CO_2}^3 \cdot c_{H_2O}^4 - k_1 \cdot c_{C_2H_2} \cdot c_{O_2}^5 \quad (9.5a)$$

$$\frac{d}{dt}c_{O_2} = 5k_2 \cdot c_{CO_2}^3 \cdot c_{H_2O}^4 - 5k_1 \cdot c_{C_2H_2} \cdot c_{O_2}^5 \quad (9.5b)$$

$$\frac{d}{dt}c_{CO_2} = 3k_1 \cdot c_{C_2H_2} \cdot c_{O_2}^5 - 3k_2 \cdot c_{CO_2}^3 \cdot c_{H_2O}^4 \quad (9.5c)$$

$$\frac{d}{dt}c_{H_2O} = 4k_1 \cdot c_{C_2H_2} \cdot c_{O_2}^5 - 4k_2 \cdot c_{CO_2}^3 \cdot c_{H_2O}^4 \quad (9.5d)$$

Notice that each reaction is driven by the concentrations of the reactants only, and not by the concentrations of the products. Notice furthermore that the stoichiometric coefficients multiply the reaction equations. This is easily understandable since, in each trade of the first type, only one molecule of C_2H_2 is consumed for every five molecules of O_2 . Consequently, the concentration of O_2 decreases five times faster than that of C_2H_2 . Similarly, in the second reaction, five molecules of O_2 are produced for every one molecule of C_2H_2 .

And yet, the set of differential equations, eq(9.5), is certainly incorrect. The reason is that the chances for six or seven different molecules to meet at any one place at any one time are minuscule, and therefore, such a reaction is very unlikely to occur. Eq(9.1) is not meant to be an adequate description of what really happens in the chemical reaction, but rather, it describes an *equilibrium of flow*, i.e., it describes the balance of various atomic trades between molecules near steady-state conditions. Whether a particular stoichiometrically feasible reaction actually can take place or not, and if yes at what reaction rate, is a difficult question to answer. We cannot answer this question without looking in detail at the *energy balance* in the trade in addition to the *mass balance* which is governed by the stoichiometry. In general, if more than three or maximum four reactant molecules are involved in a proposed chemical reaction, that reaction will never occur in one step.

Let us look at some simpler reactions to explain this concept. Hydrogen gas and iodine vapor can react to form gaseous hydrogen iodide:



As before, the reaction can take place in both directions. We decompose the equilibrium reaction into two separate reactions:



which can be described by the following (correct) set of differential equations:

$$\frac{d}{dt}c_{H_2} = k_2 \cdot c_{HI}^2 - k_1 \cdot c_{H_2} \cdot c_{I_2} \quad (9.8a)$$

$$\frac{d}{dt}c_{I_2} = k_2 \cdot c_{HI}^2 - k_1 \cdot c_{H_2} \cdot c_{I_2} \quad (9.8b)$$

$$\frac{d}{dt}c_{HI} = 2k_1 \cdot c_{H_2} \cdot c_{I_2} - 2k_2 \cdot c_{HI}^2 \quad (9.8c)$$

We can investigate what happens in the equilibrium, i.e., after a long time. We assume that an equilibrium of flow is reached in the form of a steady-state solution of our set of differential equations. In the steady-state, all derivatives are zero, thus:

$$k_2 \cdot c_{HI}^2 - k_1 \cdot c_{H_2} \cdot c_{I_2} = 0.0 \quad (9.9a)$$

$$2k_1 \cdot c_{H_2} \cdot c_{I_2} - 2k_2 \cdot c_{HI}^2 = 0.0 \quad (9.9b)$$

and therefore:

$$\frac{c_{HI}^2}{c_{H_2} \cdot c_{I_2}} = \frac{k_1}{k_2} = \text{constant} \quad (9.10)$$

In the equilibrium, a constant ratio exists between the concentrations of the different species irrespective of the chosen initial conditions. (This "constant" may still depend on temperature since the reaction rate constants k_1 and k_2 are temperature dependent.)

Let us now look at another similar reaction:



From the previous discussion, we would expect that, in the steady-state:

$$\frac{c_{HBr}^2}{c_{H_2} \cdot c_{Br_2}} = \text{constant} \quad (9.12)$$

However, experimental laboratory results prove eq(9.12) to be incorrect. This indicates that, in reality, a somewhat different reaction takes place. By experiment, it was verified that the production rate of HBr is proportional to the concentration of H_2 , but it is proportional to the square root of the concentration of Br_2 :

$$\frac{d}{dt}c_{HBr} \propto c_{H_2} \cdot c_{Br_2}^{1/2} \quad (9.13)$$

This experimental result can be explained by the following set of reactions:

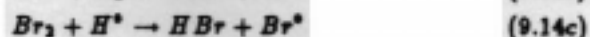

It turns out that H_2 and Br_2 are much too inert to engage in any "extramarital" relationships. However, if either a Br^* atom or an H^* atom is "single", it will rather steal the "partner" of an existing "couple" than stay single. Eq(9.14a) denotes a *fast equilibrium* reaction, i.e., Br_2 "couples" sometimes split for a while and recombine with other "single" Br^* atoms. Eq(9.14c) denotes a *fast* reaction, i.e., H^* atoms are very unhappy individuals who will reengage at once. Consequently, very few single H^* atoms are around at any one time, and the chances for two such H^* atoms to meet are negligible. "Marriages" between single Br^* and single H^* atoms are more likely to happen, but even they hardly ever occur because the chances to meet are so small. Eq(9.14b) denotes a *slow equilibrium* reaction, i.e., while most single Br^* atoms will recombine again with other single Br^* atoms, some get "frustrated" before they can find an appropriate new "partner" and attract one partner of an existing H_2 "couple" instead. Single H^* atoms are so eager to reengage that they are sometimes able to "steal" the H^* "partner" of an existing HBr "couple".

The three reactions eq(9.14) can be expanded into:

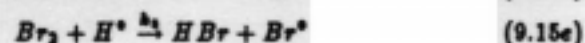
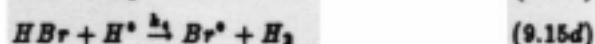
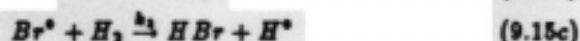

with typical reaction rate constants of $k_1 = 25.13 \text{ sec}^{-1}$, $k_2 = 1.057 \cdot 10^7 \text{ m}^3 \text{ sec}^{-1} \text{ mole}^{-1}$, $k_3 = 4.44 \cdot 10^6 \text{ m}^3 \text{ sec}^{-1} \text{ mole}^{-1}$, $k_4 = 188.6 \text{ m}^3 \text{ sec}^{-1} \text{ mole}^{-1}$, and $k_5 = 1886.0 \text{ m}^3 \text{ sec}^{-1} \text{ mole}^{-1}$, at a temperature of 900°K . The molar concentrations are measured in mole m^{-3} . Eq(9.15) leads to the following set of differential equations:

$$\frac{d}{dt}c_{Br_2} = -k_1 \cdot c_{Br_2} + k_2 \cdot c_{Br^*}^2 - k_5 \cdot c_{H^*} \cdot c_{Br_2} \quad (9.16a)$$

$$\begin{aligned} \frac{d}{dt}c_{Br^*} = & 2k_1 \cdot c_{Br_2} - 2k_2 \cdot c_{Br^*}^2 - k_3 \cdot c_{H_2} \cdot c_{Br^*} \\ & + k_4 \cdot c_{HB^*} \cdot c_{H^*} + k_5 \cdot c_{H^*} \cdot c_{Br_2} \end{aligned} \quad (9.16b)$$

$$\frac{d}{dt}c_{H_2} = -k_3 \cdot c_{H_2} \cdot c_{Br^*} + k_4 \cdot c_{HB^*} \cdot c_{H^*} \quad (9.16c)$$

$$\frac{d}{dt}c_{H^*} = k_3 \cdot c_{H_2} \cdot c_{Br^*} - k_4 \cdot c_{HB^*} \cdot c_{H^*} - k_5 \cdot c_{H^*} \cdot c_{Br_2} \quad (9.16d)$$

$$\frac{d}{dt}c_{HB^*} = k_3 \cdot c_{H_2} \cdot c_{Br^*} - k_4 \cdot c_{HB^*} \cdot c_{H^*} + k_5 \cdot c_{H^*} \cdot c_{Br_2} \quad (9.16e)$$

The overall reaction rate is dominated by the slowest reaction, i.e., by eq(9.16e). Since the concentration of H^* atoms is very small at all times, eq(9.16e) is dominated by the k_3 term. Therefore, we can write:

$$\frac{d}{dt}c_{HB^*} \approx k_3 \cdot c_{H_2} \cdot c_{Br^*} \quad (9.17)$$

Since the equilibrium reaction eq(9.14a) is much faster, we can analyze this equation under steady-state conditions:

$$k_1 \cdot c_{Br_2} - k_2 \cdot c_{Br^*}^2 = 0.0 \quad (9.18)$$

and thus:

$$c_{Br^*} = \sqrt{\frac{k_1}{k_2} \cdot c_{Br_2}} = k_{24} \cdot c_{Br_2}^{1/2} \quad (9.19)$$

Plugging eq(9.19) into eq(9.17), we find:

$$\frac{d}{dt}c_{HB^*} \approx k_3 k_{24} \cdot c_{H_2} \cdot c_{Br_2}^{1/2} \quad (9.20)$$

as shown in the laboratory experiments.

While the above formulation is the traditionally used form of reaction kinetics equations, we wish to reformulate the reaction equations in terms of number of moles and molar flow rates.

We first need to introduce the concept of a "mole". Traditionally, the amount of a substance was either measured in terms of its weight (for solid materials), or in terms of its volume (for liquids). In physics, it became more practical to express the amount of any substance through its mass, since this nomenclature simplifies the formulation of Newton's law. In chemistry, this approach is not convenient, since chemical reactions trade substances in a fixed ratio among the involved types of molecules (or atoms). Unfortunately, 1 kg of one chemical substance contains a different number of molecules (atoms) than 1 kg of another chemical substance. Thus, it is more convenient to express the amount of a chemical substance by counting the number of molecules (or atoms) contained in the measured quantity.

A pure substance is a substance which contains only one chemical species, i.e., one type of molecules. The molecular mass of a chemical species can be roughly expressed as the number of heavy particles (protons and neutrons) contained in the species multiplied by the mass of a heavy particle. Consequently, the number of molecules contained in any amount of a pure substance can be expressed as the ratio between its mass and its molecular mass.

However, by using the molecular mass, we end up with very large numbers at all times. Therefore, it is customary to normalise masses in a different way. We count the number L of atoms contained in 12 gm of carbon C^{12} . In some references, L is called Avogadro's number, while other texts refer to L as Loschmidt's number. Similarly, the number of molecules contained in 2 gm of hydrogen gas H_2 is also L . In general, L is a constant which measures the number of molecules (atoms) contained in k gm of any pure substance, where k denotes the number of heavy particles (protons and neutrons) contained in one molecule (atom) of the substance. L has a value of $6.025 \cdot 10^{23}$.

One "mole" of any pure substance is the amount that contains L molecules (atoms). The molar mass of any substance is defined as the mass of one mole of the substance, i.e., the molar mass of any substance is the product of L and its molecular mass. The molar mass of carbon C^{12} is 12 gm, while the molar mass of hydrogen gas H_2 is 2 gm. We can, thus, express the amount of a pure substance as the ratio between its mass and its molar mass, i.e., by counting the number of moles contained in the measured quantity. The mole is the measurement unit introduced to measure the number of moles of any pure substance.

The *molar concentration* of any pure substance is defined as the number of moles contained in the measured quantity divided by the volume that this quantity occupies. Consequently, molar concentrations are measured in *mole m⁻³*.

The *molar flow rate* describes the change of the number of moles over time, i.e., it is the derivative of the number of moles with respect to time. Consequently, molar flow rates are measured in *mole sec⁻¹*.

Sometimes, it is useful to measure the amount of a mixture of pure substances. The number of moles of any substance is the sum of the number of moles of the pure substances contained in the mixture.

It is our goal to reformulate the reaction kinetics equations in terms of number of moles and molar flow rates. Let me explain this concept by means of the previously used H_2 - Br_2 reaction system. We can rewrite the set of differential equations eq(9.16) in terms of the number of moles. Let the quantity n_{H_2O} denote the number of moles of water vapor. The molar concentration is the number of moles divided by the total volume, for example:

$$c_{H_2O} = \frac{n_{H_2O}}{V} \quad (9.21)$$

Therefore, eq(9.16) becomes:

$$\frac{d}{dt} \left(\frac{n_{Br_2}}{V} \right) = -k_1 \cdot \frac{n_{Br_2}}{V} + k_2 \cdot \left(\frac{n_{Br^*}}{V} \right)^2 - k_3 \cdot \frac{n_{H^*}}{V} \cdot \frac{n_{Br_2}}{V} \quad (9.22a)$$

$$\begin{aligned} \frac{d}{dt} \left(\frac{n_{Br^*}}{V} \right) = & 2k_1 \cdot \frac{n_{Br_2}}{V} - 2k_2 \cdot \left(\frac{n_{Br^*}}{V} \right)^2 - k_3 \cdot \frac{n_{H_2}}{V} \cdot \frac{n_{Br^*}}{V} \\ & + k_4 \cdot \frac{n_{HBr}}{V} \cdot \frac{n_{H^*}}{V} + k_5 \cdot \frac{n_{H^*}}{V} \cdot \frac{n_{Br_2}}{V} \end{aligned} \quad (9.22b)$$

$$\frac{d}{dt} \left(\frac{n_{H_2}}{V} \right) = -k_3 \cdot \frac{n_{H_2}}{V} \cdot \frac{n_{Br^*}}{V} + k_4 \cdot \frac{n_{HBr}}{V} \cdot \frac{n_{H^*}}{V} \quad (9.22c)$$

$$\frac{d}{dt} \left(\frac{n_{H^*}}{V} \right) = k_3 \cdot \frac{n_{H_2}}{V} \cdot \frac{n_{Br^*}}{V} - k_4 \cdot \frac{n_{HBr}}{V} \cdot \frac{n_{H^*}}{V} - k_5 \cdot \frac{n_{H^*}}{V} \cdot \frac{n_{Br_2}}{V} \quad (9.22d)$$

$$\frac{d}{dt} \left(\frac{n_{HBr}}{V} \right) = k_3 \cdot \frac{n_{H_2}}{V} \cdot \frac{n_{Br^*}}{V} - k_4 \cdot \frac{n_{HBr}}{V} \cdot \frac{n_{H^*}}{V} + k_5 \cdot \frac{n_{H^*}}{V} \cdot \frac{n_{Br_2}}{V} \quad (9.22e)$$

Let ν_{H_2O} denote the molar flow rate of water vapor, i.e., the change of the number of moles of water vapor with respect to time:

$$\nu_{H_2O} = \frac{d}{dt} n_{H_2O} \quad (9.23)$$

and let q be the volume flow rate, i.e. the derivative of the total volume V with respect to time:

$$q = \frac{dV}{dt} \quad (9.24)$$

With this notation, eq(9.22) can be rewritten as follows:

$$\nu_{Br_2} = -k_1 \cdot n_{Br_2} + k_2 \cdot \left(\frac{n_{Br^*}^2}{V}\right) - k_5 \cdot \left(\frac{n_{H^*} \cdot n_{Br_2}}{V}\right) + q \cdot \left(\frac{n_{Br_2}}{V}\right) \quad (9.25a)$$

$$\begin{aligned} \nu_{Br^*} = & 2k_1 \cdot n_{Br_2} - 2k_2 \cdot \left(\frac{n_{Br^*}^2}{V}\right) - k_3 \cdot \left(\frac{n_{H_2} \cdot n_{Br^*}}{V}\right) \\ & + k_4 \cdot \left(\frac{n_{HBr} \cdot n_{H^*}}{V}\right) + k_5 \cdot \left(\frac{n_{H^*} \cdot n_{Br_2}}{V}\right) + q \cdot \left(\frac{n_{Br^*}}{V}\right) \end{aligned} \quad (9.25b)$$

$$\nu_{H_2} = -k_3 \cdot \left(\frac{n_{H_2} \cdot n_{Br^*}}{V}\right) + k_4 \cdot \left(\frac{n_{HBr} \cdot n_{H^*}}{V}\right) + q \cdot \left(\frac{n_{H_2}}{V}\right) \quad (9.25c)$$

$$\begin{aligned} \nu_{H^*} = & k_3 \cdot \left(\frac{n_{H_2} \cdot n_{Br^*}}{V}\right) - k_4 \cdot \left(\frac{n_{HBr} \cdot n_{H^*}}{V}\right) \\ & - k_5 \cdot \left(\frac{n_{H^*} \cdot n_{Br_2}}{V}\right) + q \cdot \left(\frac{n_{H^*}}{V}\right) \end{aligned} \quad (9.25d)$$

$$\begin{aligned} \nu_{HBr} = & k_3 \cdot \left(\frac{n_{H_2} \cdot n_{Br^*}}{V}\right) - k_4 \cdot \left(\frac{n_{HBr} \cdot n_{H^*}}{V}\right) \\ & + k_5 \cdot \left(\frac{n_{H^*} \cdot n_{Br_2}}{V}\right) + q \cdot \left(\frac{n_{HBr}}{V}\right) \end{aligned} \quad (9.25e)$$

We can introduce the reaction flow rates:

$$\nu_{21} = k_1 \cdot n_{Br_2} \quad (9.26a)$$

$$\nu_{22} = k_2 \cdot \left(\frac{n_{Br^*}^2}{V}\right) \quad (9.26b)$$

$$\nu_{23} = k_3 \cdot \left(\frac{n_{H_2} \cdot n_{Br^*}}{V}\right) \quad (9.26c)$$

$$\nu_{24} = k_4 \cdot \left(\frac{n_{HBr} \cdot n_{H^*}}{V}\right) \quad (9.26d)$$

$$\nu_{25} = k_5 \cdot \left(\frac{n_{H^*} \cdot n_{Br_2}}{V}\right) \quad (9.26e)$$

and therefore:

$$\frac{d}{dt} n_{Br_2} = -\nu_{21} + \nu_{22} - \nu_{25} + q \cdot \left(\frac{n_{Br_2}}{V}\right) \quad (9.27a)$$

$$\frac{d}{dt} n_{Br^*} = 2\nu_{21} - 2\nu_{22} - \nu_{23} + \nu_{24} + \nu_{25} + q \cdot \left(\frac{n_{Br^*}}{V}\right) \quad (9.27b)$$

$$\frac{d}{dt} n_{H_2} = -\nu_{23} + \nu_{24} + q \cdot \left(\frac{n_{H_2}}{V}\right) \quad (9.27c)$$

$$\frac{d}{dt} n_{H^*} = \nu_{23} - \nu_{24} - \nu_{25} + q \cdot \left(\frac{n_{H^*}}{V}\right) \quad (9.27d)$$

$$\frac{d}{dt} n_{HBr} = \nu_{23} - \nu_{24} + \nu_{25} + q \cdot \left(\frac{n_{HBr}}{V}\right) \quad (9.27e)$$

The equations eq(9.27) look indeed funny. Let me propose the following experiment: We store a certain amount of reactants in a closed container with a movable piston. We wait until an equilibrium has been reached, i.e., until all time derivatives have died out. At such time, we pull the piston further out, i.e., we apply an external force to artificially increase the volume. The set of equations eq(9.27) claim that the number of moles will start to grow, but we know that this can't be true. The total number of moles can grow only if we add more substance to the container.

Let us look a little more closely at one of the above equations, for example the one for HBr . The flow rate balance of the substance HBr from all the reactions k_2 , k_4 , and k_5 in which the substance HBr is involved can be computed from the equation:

$$\nu_{HBr} = \nu_{22} - \nu_{24} + \nu_{25} \quad (9.28)$$

Obviously, the change in the number of moles of HBr must be equal to the balance among the reaction flow rates:

$$\frac{d}{dt}n_{HBr} = \nu_{HBr} \quad (9.29)$$

Comparing eq(9.29) with eq(9.27e), we see that the q term in eq(9.27e) is surplus. In order to correct eq(9.27), we must modify the original set of state equations eq(9.16) in the following way:

$$\frac{d}{dt}c_{Br_2} = -k_1 \cdot c_{Br_2} + k_2 \cdot c_{Br^*}^2 - k_3 \cdot c_{H^*} \cdot c_{Br_2} - \frac{q}{V} \cdot c_{Br_2} \quad (9.30a)$$

$$\begin{aligned} \frac{d}{dt}c_{Br^*} = & 2k_1 \cdot c_{Br_2} - 2k_2 \cdot c_{Br^*}^2 - k_3 \cdot c_{H^*} \cdot c_{Br^*} \\ & + k_4 \cdot c_{HBr} \cdot c_{H^*} + k_5 \cdot c_{H^*} \cdot c_{Br_2} - \frac{q}{V} \cdot c_{Br^*} \end{aligned} \quad (9.30b)$$

$$\frac{d}{dt}c_{H_2} = -k_3 \cdot c_{H_2} \cdot c_{Br^*} + k_4 \cdot c_{HBr} \cdot c_{H^*} - \frac{q}{V} \cdot c_{H_2} \quad (9.30c)$$

$$\begin{aligned} \frac{d}{dt}c_{H^*} = & k_3 \cdot c_{H_2} \cdot c_{Br^*} - k_4 \cdot c_{HBr} \cdot c_{H^*} - k_5 \cdot c_{H^*} \cdot c_{Br_2} \\ & - \frac{q}{V} \cdot c_{H^*} \end{aligned} \quad (9.30d)$$

$$\begin{aligned} \frac{d}{dt}c_{HBr} = & k_5 \cdot c_{H_2} \cdot c_{Br^*} - k_4 \cdot c_{HBr} \cdot c_{H^*} + k_5 \cdot c_{H^*} \cdot c_{Br_2} \\ & - \frac{q}{V} \cdot c_{HBr} \end{aligned} \quad (9.30e)$$

This correction term makes a lot of sense. Let us apply the same experiment as before. If we artificially increase the volume of the reactor, we know that the concentrations will start decreasing. The correction term takes care of this. The uncorrected equations eq(9.16) did not reflect the necessary change in the concentrations. Obviously, the uncorrected equations eq(9.16) are only valid for reactions that occur under constant volume conditions where $q = 0.0$ at all times.

9.3 Chemical Thermodynamics

Until now, we have looked at the mass transfer (the stoichiometry) of a chemical reaction only. If we wish to understand why chemical reactions take place, we need to look at the energy transfer as well.

Most chemical reactions are either *exothermic* or *endothermic*, i.e., they either generate or absorb heat. Quite frequently, other things happen as well. In a closed container (i.e., under constant volume), the pressure of a gas or liquid may change during the reaction, and in an open container (i.e., under constant pressure), the volume of the gas or liquid may change. This volume/pressure change can sometimes assume violent dimensions, for instance in an explosion.

This indicates that, in a chemical reaction, two different goods are actually traded, namely *mass* and *energy*. The energy traded in a chemical reaction must come from somewhere. Consequently, we must assume that a chemical substance can store energy similar to a capacitor in an electrical circuit. Let us try to define this mechanism.

According to the first and second law of thermodynamics, the change of the *internal energy* U of a chemical substance in any process (such as a change of temperature or a chemical reaction) can be described as follows:

$$\dot{U} = T \cdot \dot{S} - p \cdot \dot{V} + \sum_{\text{wi}} \mu_i \cdot \dot{n}_i \quad (9.31)$$

where T denotes the temperature, S stands for the entropy, p is the pressure, V denotes the volume, and n_i is the number of moles of substance i . Since, in any chemical reaction, energy is traded as well as mass, the flow of mass across the arrow must carry some *chemical power* along with it. Therefore, we must assume that an adjugate variable μ_i to the molar flow rate ν_i exists such that the product

of the molar flow rate and its adjugate variable is chemical power. The adjugate variable has been coined the *chemical potential* of a substance, and is measured in $J \text{ mole}^{-1}$. The chemical potential of a substance describes the amount of chemical energy stored in a mole of that substance. When the substance is traded across the arrow in a chemical reaction, its chemical energy is traded along with its mass.

If a substance is separated into several components during a chemical reaction, the sum of the chemical potentials of the products can be different from the chemical potential of the reactant. It can be either smaller or larger. If this is the case, the energy must be balanced elsewhere. For instance, if the sum of the chemical potentials of the products is smaller than the chemical potential of the reactant, the excess energy must be converted to another form, by producing heat, or by increasing the pressure, or by increasing the volume. The same argument holds for several reactants being combined into one product, or for several reactants being rearranged into several products.

We realize that matter can store energy simultaneously using three different mechanisms, a *thermic storage* (expressed through the heat capacity), a *hydraulic/pneumatic storage*, and finally a *chemical storage* (a structural storage).

Notice that the variables U , S , V , and n_i depend on the quantity of substance that acts as a storage. These are called *extensive variables*. On the other hand, T , p , and μ_i are independent of the quantity. They are called *intensive variables*. It is sometimes useful to normalize the extensive variables (i.e., make them intensive variables) by dividing through the total number of moles:

$$u = \frac{U}{n}, \quad s = \frac{S}{n}, \quad v = \frac{V}{n}, \quad z_i = \frac{n_i}{n} \quad (9.32)$$

u is called the *molar internal energy*, s is called the *molar entropy*, v is called the *molar volume*, and z_i is called the *mole fraction*. Eq.(9.31) can thus be rewritten as follows:

$$\frac{d}{dt}(n u) - T \cdot \frac{d}{dt}(n s) + p \cdot \frac{d}{dt}(n v) - \sum_{vi} \mu_i \cdot \frac{d}{dt}(n z_i) = 0.0 \quad (9.33)$$

which can be evaluated as follows:

$$n \left(\frac{dU}{dt} - T \cdot \frac{dS}{dt} + p \cdot \frac{dV}{dt} - \sum_{\nu_i} \mu_i \cdot \frac{dx_i}{dt} \right) + \frac{dn}{dt} (U - T \cdot S + p \cdot V - \sum_{\nu_i} \mu_i \cdot x_i) = 0.0 \quad (9.34)$$

Since $\frac{dn}{dt}$ is independent of n , the two parantheses must both be equal to zero:

$$U = T \cdot S - p \cdot V + \sum_{\nu_i} \mu_i \cdot x_i \quad (9.35a)$$

$$\frac{dU}{dt} = T \cdot \frac{dS}{dt} - p \cdot \frac{dV}{dt} + \sum_{\nu_i} \mu_i \cdot \frac{dx_i}{dt} \quad (9.35b)$$

Eq(9.35a) provides us with an explicit formula for the internal energy stored in a mole of any substance. Notice the difference to electrical and mechanical systems. An electrical circuit has two separate means to store energy. The energy stored in a capacitor is:

$$E_C = \frac{1}{2} C \cdot u_C^2 \quad (9.36)$$

and thus the power flow into and out of a capacitor is:

$$P_C = \frac{dE_C}{dt} = C \cdot u_C \cdot \frac{du_C}{dt} = u_C \cdot i_C \quad (9.37)$$

similarly, for an inductor:

$$E_L = \frac{1}{2} L \cdot i_L^2, \quad P_L = \frac{dE_L}{dt} = L \cdot i_L \cdot \frac{di_L}{dt} = u_L \cdot i_L \quad (9.38)$$

i.e., while the energy formulae look different, the power is always $u \cdot i$.

The situation is similar for the potential and kinetic energy stored in physical bodies. While the energy formulae look different, the power is always $F \cdot v$ for translational motions, and $\tau \cdot \omega$ for rotational motions.

However, the situation is quite different with respect to the energy that is stored in the matter itself in three different energy storages: a thermal, a hydraulic/pneumatic, and a chemical energy storage. Let us analyze the internal hydraulic/pneumatic energy storage of a liquid or gaseous substance. The energy is stored as:

$$E_{h/p} = p \cdot V \quad (9.39)$$

Therefore, the power can be described as:

$$P_{h/p} = \frac{d}{dt}(p \cdot V) = \dot{p} \cdot V + p \cdot \dot{V} \quad (9.40)$$

Only one form of internal hydraulic/pneumatic energy exists, yet two separate mechanisms allow power to flow into or out of the storage. Hydraulic/pneumatic power can flow under conditions of constant pressure (i.e., the so-called *isobaric conditions*) using the expression $p \cdot \dot{V}$, or under conditions of constant volume (i.e., the so-called *isochoric conditions*) using the expression $\dot{p} \cdot V$. If both variables are time dependent, both power flow mechanisms occur simultaneously.

The same is true for the thermal storage. Thermal power can flow under conditions of constant temperature (i.e., the so-called *isothermic conditions*) using the expression $T \cdot \dot{S}$, or under conditions of constant entropy (i.e., the so-called *isentropic conditions*) using the expression $\dot{T} \cdot S$. If both variables are time dependent, both power flow mechanisms occur simultaneously.

Similarly, two power flow mechanisms exist also for the chemical power. However, by specifying the free thermal and the free hydraulic/pneumatic conditions, the system is completely determined, i.e., we cannot choose to execute a chemical reaction under conditions of constant chemical potential or constant molar flow rate.

Notice that all three internal energy storages describe properties of the matter itself. They exist irrespectively of whether the matter is moved around or is kept in one place. If we move a liquid or a gas around macroscopically, we must in addition consider its potential and kinetic energies which are also expressed in terms of the pressure p , the mass flow rate q , and the volume V . Yet, these energy storages are different from the internal hydraulic/pneumatic energy storage of the matter itself.

Notice further that the sign of the internal hydraulic/pneumatic energy term in eq(9.35a) is opposite to the sign of the internal thermic and chemical energy terms. We shall explain this fact later.

Two other energy functions are commonly used in thermodynamics:

$$H = U + p \cdot V = T \cdot S + \sum_{\mathbf{w}} \mu_{\mathbf{i}} n_{\mathbf{i}} \quad (9.41a)$$

$$G = H - T \cdot S = \sum_{\mathbf{w}} \mu_{\mathbf{i}} n_{\mathbf{i}} \quad (9.41b)$$

H is called the *enthalpy* of the substance, and G is called the *Gibbs free energy* of the substance. G measures the total amount of chemical (structural) energy stored in the substance. Of course, also H

and G are extensive variables which can be made intensive by normalization:

$$\mathcal{H} = \frac{H}{n} = U + p \cdot V = T \cdot S + \sum_{\mathbf{w}_i} \mu_i z_i \quad (9.42a)$$

$$\mathcal{G} = \frac{G}{n} = \mathcal{H} - T \cdot S = \sum_{\mathbf{w}_i} \mu_i z_i \quad (9.42b)$$

\mathcal{H} is called the *molar enthalpy* of the substance, and \mathcal{G} is called the *molar Gibbs free energy* of the substance. \mathcal{G} measures the total amount of chemical (structural) energy stored in 1 mole of the substance.

Let me analyze this relation a little further:

$$G = H - T \cdot S = U + p \cdot V - T \cdot S \quad (9.43)$$

and therefore:

$$\dot{G} = \dot{U} + \dot{p} \cdot V + p \cdot \dot{V} - \dot{T} \cdot S - T \cdot \dot{S} \quad (9.44)$$

We plug \dot{U} into eq(9.44) from eq(9.31):

$$\dot{G} = -\dot{T} \cdot S + \dot{p} \cdot V + \sum_{\mathbf{w}_i} \mu_i \cdot \dot{z}_i \quad (9.45)$$

However, since:

$$G = \sum_{\mathbf{w}_i} \mu_i \cdot z_i \quad (9.46)$$

we can also write:

$$\dot{G} = \sum_{\mathbf{w}_i} \dot{\mu}_i \cdot z_i + \sum_{\mathbf{w}_i} \mu_i \cdot \dot{z}_i \quad (9.47)$$

A comparison with eq(9.45) shows that:

$$\sum_{\mathbf{w}_i} \dot{\mu}_i \cdot z_i = \dot{p} \cdot V - T \cdot \dot{S} \quad (9.48)$$

Finally, we know that the total energy in a closed system is constant. If we can neglect other forms of energy (such as mechanical energy or electrical energy), the internal energy of the closed system is constant:

$$U = \text{constant} \quad (9.49)$$

and therefore, from eq(9.31):

$$\dot{U} = T \cdot \dot{S} - p \cdot \dot{V} + \sum_{w_i} \mu_i \cdot \nu_i = 0.0 \quad (9.50)$$

Eq(9.48) and eq(9.50) together provide us with two separate power balance equations:

$$p \cdot \dot{V} = T \cdot \dot{S} + \sum_{w_i} \mu_i \cdot \nu_i \quad (9.51a)$$

$$\dot{p} \cdot V = \dot{T} \cdot S + \sum_{w_i} \dot{\mu}_i \cdot n_i \quad (9.51b)$$

Eq(9.51b) is one form of the Gibbs–Duhem equation.

Notice that our discussion evolves around power rather than energy. Traditionally, the chemical thermodynamics literature discusses the equilibrium (i.e., the steady-state behavior) of the chemical reactions rather than analyzing their dynamics. Consequently, these treatises always concentrate on the conservation of energy rather than the power balance. However, for our purposes, it is more natural to concentrate on the power balance.

In a chemical reaction system, chemical energy is traded among the various substances involved in the various reactions. However, the trade is not always balanced. Either a surplus of chemical power or a lack of chemical power may exist. If the chemical power balance of a reaction system results in surplus chemical power (i.e., $G < 0.0$), the excess power is converted into either thermic power, or hydraulic/pneumatic power, or both. If the chemical power balance results in a lack of chemical power (i.e., $G > 0.0$), power must be imported from either the thermic or the pneumatic/hydraulic side. A chemical reaction system strives to maintain the smallest amount of chemical energy possible. Consequently, reactions with $G < 0.0$ will take place *spontaneously*, while reaction with $G > 0.0$ can only occur forcefully, i.e., by forcing power into the chemical system, for example through external heating.

In a chemical reaction, the total power must be balanced. The chemical power stored in all products minus the chemical power stored in all reactants is the power that is available for conversion into other forms of power. This power (which can assume either positive or negative values) will be split among thermic power (through either production or consumption of heat), and hydraulic/pneumatic power (through either volume or pressure increase or reduction).

9.4 The Equation of State

We have seen that chemical systems which are completely described through their internal energy contain three internal energy storages: a chemical storage, a thermic storage, and a hydraulic/pneumatic storage. Thus, such systems are defined through six different types of variables, namely T , S , p , V , μ_i , and n_i . We need thus six types of equations to completely describe the dynamics of the overall system. Until now, we met the reaction equations, which are used to compute the n_i , and the two power balance equations, of which eq(9.51a) is usually employed to compute the entropy S , while eq(9.51b) is used to determine the chemical potentials μ_i .

Since the system has two ports to the environment, a thermal port and a hydraulic/pneumatic port, one relation exists between the two thermal variables and another exists between the two hydraulic/pneumatic variables which are determined by the environment. We can decide to control the temperature of the reaction system such that T stays constant during the entire reaction. In that case, T is modeled as a temperature source, while eq(9.51a) determines the resulting entropy flow. This is a very common scenario. A chemical reaction which takes place under conditions of constant temperature is called an *isothermic reaction*. Independently, we can choose one variable among the two hydraulic/pneumatic variables. If we let the reaction take place in an open container, we can assume that the pressure p stays constant throughout the entire reaction. This is the normal assumption for *batch reactors*. A chemical reaction which takes place under conditions of constant pressure is called an *isobaric reaction*. Eq(9.51b) shows that, under isothermic and isobaric conditions:

$$\sum_{\nu_i} \dot{\mu}_i \cdot n_i = 0.0 \quad (9.52)$$

We shall see that, in this case:

$$\mu_i = \text{constant} \quad (9.53)$$

i.e., the chemical potentials of all substances i involved in the reaction are constant.

Alternatively, if we let the reaction take place in a closed container which is constantly kept full, we can assume that the volume V stays constant throughout the entire reaction. This is the normal assumption for *tubular reactors*. A chemical reaction which takes place under conditions of constant volume is called an *isochoric reaction*.

We are still missing the sixth and last equation. Yet another additional equation exists which relates the various state variables to each other. This is commonly referred to as the *equation of state*.

For an ideal gas, the equation of state is:

$$p \cdot V = n \cdot R \cdot T \quad (9.54)$$

where p denotes the pneumatic pressure of the gas, V represents its volume, R is the gas constant ($R = 8.314 \text{ J} \cdot \text{K}^{-1} \text{ mole}^{-1}$), T is the absolute temperature of the gas (measured in $^{\circ}\text{K}$), and n denotes the total number of moles.

The equation of state relates the pressure p , the volume V , and the temperature T to each other. A real gas does not obey eq(9.54) exactly. Yet, a static relation still exists between the three variables p , V , and T . Several approximate equations for various types of gases have been developed, and can be found in the literature. Systems which are characterized by a static relation between p , V , and T are often called *PVT systems*.

Liquids, on the other hand can be assumed incompressible. Under this assumption, a direct proportionality relation exists between the number of moles of a liquid and its volume:

$$V \propto n \quad (9.54^{alt})$$

For example, 1 mole of H_2O has a mass of 18 gr which, in the liquid phase, occupies a volume of 18 cm^3 . The equation of state is used to compute one of the hydraulic/pneumatic variables.

Unfortunately, there is a problem with the equation of state. This equation is actually a *steady-state equation*, i.e., it is only valid in a strict sense under equilibrium conditions. It should be replaced by a more general equation which is true also far from equilibrium. Unfortunately, We haven't been able to find such a generalized equation yet.

Let us now discuss ideal gas phase reactions in more detail. According to eq(9.54), if we increase the temperature of a fixed amount of gas, either its pressure or its volume must grow. The same is true if we increase the amount of gas under constant temperature conditions. The power balance equations must reflect this fact. Consequently, eq(9.50) must exhibit the variables p and V on one side of the equal sign, whereas n and T must show up on the other side. This explains the opposite sign of the hydraulic/pneumatic energy term in eq(9.35a).

The product $p \cdot V$ is the internal pneumatic energy content of the gas. It would be useful if we could assign a value to the pneumatic

energy content of each gaseous component in a gas mixture. Traditionally, this has been accomplished through the introduction of the *partial gas pressure* of a component gas. Let us perform the following experiment. We shall decompose the gas mixture into its component gases, and store each component gas in a container of the same size (volume) that the original container had. We measure the pressure of the gases in each of these containers. This is called the *partial gas pressure*. According to *Dalton's law*, the sum of all partial gas pressures equals the pressure of the gas mixture. We can thus rewrite eq(9.54) as follows:

$$\left(\sum_{v_i} p_i\right) \cdot V = \left(\sum_{v_i} n_i\right) \cdot R \cdot T \quad (9.55)$$

where n_i denotes the number of moles of the component gas i . We can then decompose this equation into its individual components:

$$p_i \cdot V = n_i \cdot R \cdot T \quad (9.56)$$

However, if we operate under conditions of constant temperature T and constant pressure p , it may be more appealing to perform a different experiment. This time, we keep all the gas molecules together, but we sort them such that all B_{r_2} molecules are in one corner, and all H_2 molecules are in another. We can then "measure" the *partial volume* that each of the component gases occupies, and using the same argument as before, we can write:

$$p \cdot V_i = n_i \cdot R \cdot T \quad (9.57)$$

where V_i is the partial volume of component gas i , and p is the pressure of the gas mixture. This experiment may be hard to perform in practice, but according to *Avogadro's law*, one mole of an ideal gas under constant pressure and temperature occupies exactly the same volume as one mole of any other ideal gas (a direct consequence of the equation of state). At a pressure of $p = 1 \text{ atm} = 760 \text{ Torr} = 1.0132 \cdot 10^5 \text{ N m}^{-2}$ and a temperature of $T = 0^\circ\text{C} = 273.15^\circ\text{K}$, a mole of any ideal gas occupies a volume of $V = \frac{RT}{p} = 22.4 \text{ liter} = 0.0224 \text{ m}^3$. Therefore, we can compute the partial pressures (*Dalton's law*) and the partial volumes (*Avogadro's law*) by use of the *mole fractions*:

$$p_i = \frac{n_i}{n} \cdot p = x_i \cdot p \quad (9.58a)$$

$$V_i = \frac{n_i}{n} \cdot V = x_i \cdot V \quad (9.58b)$$

We can use the equation of state to determine the volume:

$$V = \frac{n \cdot R \cdot T}{p} \quad (9.59)$$

and if we assume the pressure p and the temperature T to be constant, we can compute the derivative of eq(9.59) as follows:

$$q = \frac{\nu \cdot R \cdot T}{p} \quad (9.60)$$

or for any component gas:

$$q_i = \frac{\nu_i \cdot R \cdot T}{p} \quad (9.61)$$

Let us plug eq(9.61) into the reaction equations:

$$q_{B_{r_2}} = \nu_{B_{r_2}} \cdot \left(\frac{R \cdot T}{p}\right) = (-\nu_{21} + \nu_{22} - \nu_{23}) \cdot \left(\frac{R \cdot T}{p}\right) \quad (9.62a)$$

$$q_{B_{r_3}} = \nu_{B_{r_3}} \cdot \left(\frac{R \cdot T}{p}\right) = (2\nu_{21} - 2\nu_{22} - \nu_{23} + \nu_{24} + \nu_{25}) \cdot \left(\frac{R \cdot T}{p}\right) \quad (9.62b)$$

$$q_{H_2} = \nu_{H_2} \cdot \left(\frac{R \cdot T}{p}\right) = (-\nu_{23} + \nu_{24}) \cdot \left(\frac{R \cdot T}{p}\right) \quad (9.62c)$$

$$q_{H^*} = \nu_{H^*} \cdot \left(\frac{R \cdot T}{p}\right) = (\nu_{23} - \nu_{24} - \nu_{25}) \cdot \left(\frac{R \cdot T}{p}\right) \quad (9.62d)$$

$$q_{HB_r} = \nu_{HB_r} \cdot \left(\frac{R \cdot T}{p}\right) = (\nu_{23} - \nu_{24} + \nu_{25}) \cdot \left(\frac{R \cdot T}{p}\right) \quad (9.62e)$$

The total volume flow is the sum of all component volume flows:

$$q = \sum_{wi} q_i = \nu \cdot \left(\frac{R \cdot T}{p}\right) = (\nu_{21} - \nu_{23}) \cdot \left(\frac{R \cdot T}{p}\right) \quad (9.63)$$

We can split this equation differently into reaction terms rather than component terms:

$$q_{21} = (2 - 1) \cdot \nu_{21} \cdot \frac{R \cdot T}{p} \quad (9.64a)$$

$$q_{22} = (1 - 2) \cdot \nu_{22} \cdot \frac{R \cdot T}{p} \quad (9.64b)$$

$$q_{23} = (2 - 2) \cdot \nu_{23} \cdot \frac{R \cdot T}{p} \quad (9.64c)$$

$$q_{24} = (2 - 2) \cdot \nu_{24} \cdot \frac{R \cdot T}{p} \quad (9.64d)$$

$$q_{25} = (2 - 2) \cdot \nu_{25} \cdot \frac{R \cdot T}{p} \quad (9.64e)$$

where the numbers between the parentheses denote the difference of the number of gaseous product particles minus the number of gaseous reactant particles. In the reactions k_2 , k_4 , and k_5 , two gaseous molecules are traded for two other gaseous molecules. Consequently, in accordance with Avogadro's law, the volume does not change, and thus, pneumatic power is neither generated nor absorbed. In reaction k_1 , two Br^* atoms are produced for each Br_2 molecule. Consequently, the partial volume grows. In reaction k_3 , two Br^* atoms are consumed for each Br_2 molecule that is being generated. Consequently, the partial volume decreases.

Let us call the balance factor between the parentheses multiplied by the reaction flow rate ν_k , the *effective reaction flow rate*, and denote it with the symbol νe_k .

Molecules in their liquid and/or solid phases don't contribute to the effective reaction flow rate since the volume occupied by liquids and solid bodies is negligible in comparison with the volume occupied by gases, and since they can be assumed non-compressible.

9.5 Chemical Reaction Bond Graphs

The six types of dynamic equations relating the six types of variables to each other can be represented in a bond graph. Fig.9.1 shows the bond graph for the (slightly simplified) hydrogen/bromine reaction system:

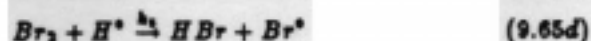
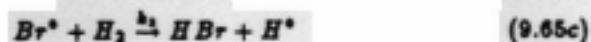

where the least important reaction k_4 was left out in order to keep the bond graph a planar graph. The bond graph has been drawn under the assumptions of *isothermic* and *isobaric* conditions.

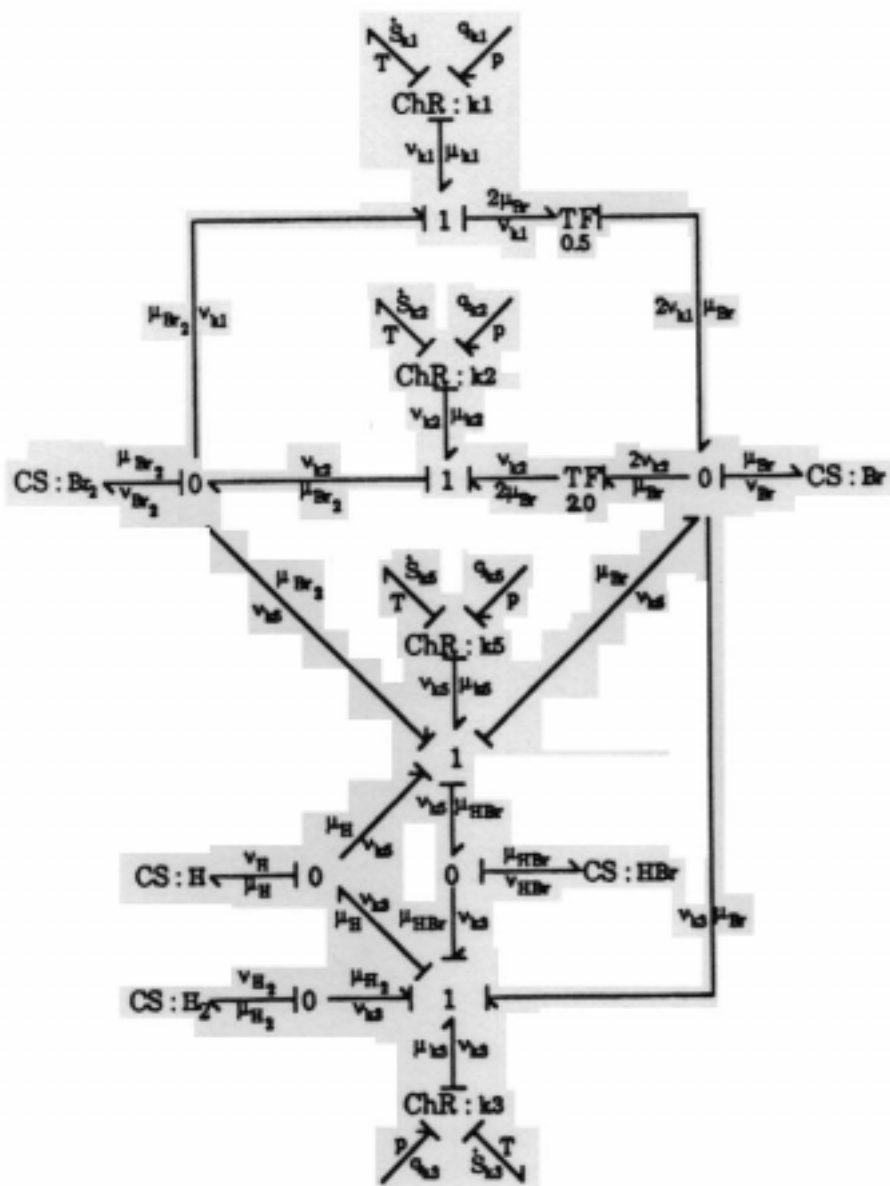

Figure 9.1. Bond graph of the isothermic and isobaric H_2-Br_2 reaction

In the bond graph, each of the five species Br_2 , Br^* , H_2 , H^* , and HBr is represented by a 0-junction. Attached to each of these 0-junctions is a new element, the *CS* element. The *CS* element represents a *capacitive source*. In the capacitive source, mass is accumulated. The molar flow into (out of) the capacitive source is the balance of the flows into (out of) the various reactions in which the species is involved, for example:

$$\nu_{Br_2} = \nu_{k_2} - \nu_{k_1} - \nu_{k_3} \quad (9.66)$$

The species Br_2 is involved in the reactions k_1 , k_2 , and k_3 . The chemical power $\mu_{Br_2} \cdot \nu_{k_1}$ flows into the reaction k_1 , and so does the chemical power $\mu_{Br_2} \cdot \nu_{k_3}$ flow into the reaction k_3 . The reaction k_2 delivers the chemical power $\mu_{Br_2} \cdot \nu_{k_2}$ back to the species Br_2 . These powers are balanced by the chemical power $\mu_{Br_2} \cdot \nu_{Br_2}$, which flows into (out of) the capacitive source. In the capacitive source, the (constant) chemical potential μ_{Br_2} is computed using a formula which we haven't discussed yet.

Each chemical reaction is represented by a 1-junction. The 1-junction balances the chemical powers into (out of) the reaction with the other types of power, namely thermic power and hydraulic/pneumatic power. For example, the reaction k_2 receives chemical power from the species Br^* and H_2 , and delivers chemical power to the species H^* and HBr . The balance among these chemical powers $\mu_{k_2} \cdot \nu_{k_2}$ is the power which, in the chemical reaction, will be converted into other types of power. μ_{k_2} can thus be computed from the formula:

$$\mu_{k_2} = \mu_{H^*} + \mu_{HBr} - \mu_{Br^*} - \mu_{H_2} \quad (9.67)$$

Attached to each of the 1-junctions is another new bond graph element, the *ChR* element which describes the chemical reaction. The *chemical reactor ChR* converts power between its chemical, thermic, and hydraulic/pneumatic forms. Assuming that the temperature T is constant (i.e., we operate under *isothermic conditions*) and that the hydraulic/pneumatic pressure p is constant (i.e., we operate under *isobaric conditions*), the chemical reactor computes the three flow rates, namely the partial entropy flow \dot{S}_k , of the reaction (from eq(9.51a)), the partial volume flow q_k , of the reaction (from eq(9.64)), and the partial molar flow ν_k , of the reaction (from eq(9.26)).

The *ChR* element is very similar to the previously encountered *RS* element. As the *RS* element, the *ChR* element is basically an ideal energy transducer which balances the power of its ports. No energy is stored inside the *ChR* element.

The equation for the molar flow rate is modulated by the number of moles of all the reactant species. The modulating signal paths have been omitted from the bond graph of Fig.9.1 to avoid overcrowding.

The stoichiometric coefficients are represented by transformers. Reaction k_1 delivers twice the flow rate ν_{k_1} to the species Br^* . Since the chemical potential of this species is μ_{Br^*} , and since the flow rate out of the 1-junction must be ν_{k_1} , we have to assume a chemical potential of $2\mu_{Br^*}$ at the 1-junction to balance the power along this power path.

Let us look a little more closely at the relations between the flow rates and chemical potentials of the component gases on the one hand versus those of the chemical reactions on the other. We can write these relations in a matrix form as follows:

$$\begin{pmatrix} \nu_{Br_2} \\ \nu_{Br^*} \\ \nu_{H_2} \\ \nu_{H^*} \\ \nu_{HBr} \end{pmatrix} = \begin{pmatrix} -1 & 1 & 0 & 0 & -1 \\ 2 & -2 & -1 & 1 & 1 \\ 0 & 0 & -1 & 1 & 0 \\ 0 & 0 & 1 & -1 & -1 \\ 0 & 0 & 1 & -1 & 1 \end{pmatrix} \cdot \begin{pmatrix} \nu_{k_1} \\ \nu_{k_2} \\ \nu_{k_3} \\ \nu_{k_4} \\ \nu_{k_5} \end{pmatrix} \quad (9.68a)$$

$$\begin{pmatrix} \mu_{k_1} \\ \mu_{k_2} \\ \mu_{k_3} \\ \mu_{k_4} \\ \mu_{k_5} \end{pmatrix} = \begin{pmatrix} -1 & 2 & 0 & 0 & 0 \\ 1 & -2 & 0 & 0 & 0 \\ 0 & -1 & -1 & 1 & 1 \\ 0 & 1 & 1 & -1 & -1 \\ -1 & 1 & 0 & -1 & 1 \end{pmatrix} \cdot \begin{pmatrix} \mu_{Br_2} \\ \mu_{Br^*} \\ \mu_{H_2} \\ \mu_{H^*} \\ \mu_{HBr} \end{pmatrix} \quad (9.68b)$$

which can be written in a more compact way:

$$\vec{\nu}_s = \mathbf{N} \cdot \vec{\nu}_r, \quad \vec{\mu}_r = \mathbf{M} \cdot \vec{\mu}_s \quad (9.69)$$

where:

$$\mathbf{M} = \mathbf{N}' \quad (9.70)$$

Notice that, in this example, the matrices \mathbf{N} and \mathbf{M} are singular. In fact, these two matrices don't even have to be square. Consequently, we can compute the vector of the substance flow rates $\vec{\nu}_s$ from the vector of the reaction flow rates $\vec{\nu}_r$, but not vice versa, and we can

compute the vector of the reaction potentials $\vec{\mu}_r$ from the vector of the substance potentials $\vec{\mu}_s$, but not vice versa.

Let us analyze the chemical power balance for the hydrogen / bromine reaction under isothermic and isobaric conditions.

$$\begin{aligned}
 \dot{G} &= \sum_{\mathbf{w}_i} (\mu_i \cdot \nu_i) \\
 &= \mu_{Br_2} \nu_{Br_2} + \mu_{Br} \nu_{Br} + \mu_{H_2} \nu_{H_2} + \mu_H \nu_H + \mu_{HBr} \nu_{HBr} \\
 &= \mu_{Br_2} (-\nu_{21} + \nu_{22} - \nu_{23}) \\
 &\quad + \mu_{Br} (2\nu_{21} - 2\nu_{22} - \nu_{23} + \nu_{24} + \nu_{25}) \\
 &\quad + \mu_{H_2} (-\nu_{23} + \nu_{24}) \\
 &\quad + \mu_H (\nu_{23} - \nu_{24} - \nu_{25}) \\
 &\quad + \mu_{HBr} (\nu_{23} - \nu_{24} + \nu_{25}) \\
 &= (-\mu_{Br_2} + 2\mu_{Br}) \nu_{21} \\
 &\quad + (\mu_{Br_2} - 2\mu_{Br}) \nu_{22} \\
 &\quad + (-\mu_{Br} - \mu_{H_2} + \mu_H + \mu_{HBr}) \nu_{23} \\
 &\quad + (\mu_{Br} + \mu_{H_2} - \mu_H - \mu_{HBr}) \nu_{24} \\
 &\quad + (-\mu_{Br_2} + \mu_{Br} - \mu_H + \mu_{HBr}) \nu_{25} \\
 &= \mu_{21} \nu_{21} + \mu_{22} \nu_{22} + \mu_{23} \nu_{23} + \mu_{24} \nu_{24} + \mu_{25} \nu_{25} \\
 &= \sum_{\mathbf{w}_i} (\mu_{2i} \cdot \nu_{2i}) \tag{9.71}
 \end{aligned}$$

or using the more compact matrix notation:

$$\dot{G} = \vec{\mu}_s' \cdot \vec{\nu}_s = \vec{\mu}_s' \cdot (\mathbf{N} \cdot \vec{\nu}_r) = \vec{\mu}_s' \cdot (\mathbf{M}' \cdot \vec{\nu}_r) = (\vec{\mu}_s' \cdot \mathbf{M}') \cdot \vec{\nu}_r = (\mathbf{M} \cdot \vec{\mu}_s)' \cdot \vec{\nu}_r = \vec{\mu}_r' \cdot \vec{\nu}_r \tag{9.72}$$

Eq(9.72) shows that we can decompose the total chemical power either in terms of component substances or in terms of component reactions.

Let us look once more at the power balance equation eq(9.51a). We can rewrite this equation in terms of partial volume flows and partial entropy flows as follows:

$$p \cdot \sum_{\mathbf{w}_i} q_i = T \cdot \sum_{\mathbf{w}_i} \dot{S}_i + \sum_{\mathbf{w}_i} \mu_i \cdot \nu_i \tag{9.73}$$

which can also be written in terms of individual reactions rather than individual component gases:

$$p \cdot \sum_{\nu_{k_i}} q_{k_i} = T \cdot \sum_{\nu_{k_i}} \dot{S}_{k_i} + \sum_{\nu_{k_i}} \mu_{k_i} \cdot \nu_{k_i} \quad (9.74)$$

which can be written separately for reaction k_i as:

$$p \cdot q_{k_i} = T \cdot \dot{S}_{k_i} + \mu_{k_i} \cdot \nu_{k_i} \quad (9.75)$$

Eq(9.75) can be used to compute the contribution of the reaction k_i to the overall entropy flow.

The above discussion allows us to create a DYMOLA model for each chemical reactor. Below, the code for the chemical reactor k_3 is given.

```

model type CkRk3
  main cut chem(mu_k3/-nu_k3)
  cut thermk3(Temp/-Sdotk3), pneumk3(p/qk3)
  terminal nH2, nBr, V
  parameter R = 8.314
  local k3, nu_k3
  k3 = (10 * 11.43) * exp(-82400/(R * Temp))
  nu_k3 = 0.0
  p * qk3 = Temp * Sdotk3 + mu_k3 * nu_k3
  p * qk3 = nu_k3 * R * Temp
  nu_k3 = k3 * nH2 * nBr/V
end

```

The reaction rate constant k_3 depends explicitly on the temperature T . The experimentally determined k_3 characteristic was taken from Moore and Pearson [9.10]. The effective reaction flow rate ν_{k_3} is zero. In addition, the model contains three equations describing (i) the power balance across the reaction, (ii) the equation of state for the reaction, and (iii) the reaction rate equation.

Due to the rather complex modulation (the number of terms in the reaction rate equation is variable), we need to create one such model for each reaction in the system.

The CS model type can be coded in DYMOLA as follows:

```

model type CS
  main cut chem(mu/nu)
  terminal n, nu0
  nu = nu0
  der(n) = nu
end

```

The *CS* model is sufficiently simple to allow the creation of a generic model type that can be reused for all *CS* elements. The chemical potential μ_i of any substance is constant under isothermic and isobaric conditions. We still need to discuss how we determine the chemical potential μ_i .

Finally, we need to sum up all the partial volumes (pressures) and entropies in a pneumatic and a thermic model.

```

model type Pneumatic
  main cut pneuTot(p/q)
  cut pneuk1(p/-qk1), pneuk2(p/-qk2)
  cut pneuk3(p/-qk3), pneuk4(p/-qk4)
  cut pneuk5(p/-qk5)
  terminal V
  q = qk1 + qk2 + qk3 + qk4 + qk5
  der(V) = q
end

model type Thermic
  main cut thermTot(Temp/-Sdot)
  cut thermk1(Temp/Sdotk1), thermk2(Temp/Sdotk2)
  cut thermk3(Temp/Sdotk3), thermk4(Temp/Sdotk4)
  cut thermk5(Temp/Sdotk5)
  terminal S
  Sdot = Sdotk1 + Sdotk2 + Sdotk3 + Sdotk4 + Sdotk5
  der(S) = Sdot
end

```

We also still need to discuss how we can determine the initial condition for the entropy S .

If we operate under conditions of constant volume rather than constant pressure, i.e., we operate under *isochoric* conditions instead of the previously assumed *isobaric* conditions, the partial pressure approach is more adequate.

Now, we need both power balance equations:

$$0.0 = T \cdot \dot{S} + \sum_{\mathbf{w}_i} \mu_i \cdot \nu_i \quad (9.76a)$$

$$\dot{p} \cdot V = \sum_{\mathbf{w}_i} \dot{\mu}_i \cdot n_i \quad (9.76b)$$

We know that we can decompose eq(9.76a) either into component substances or into component reactions. Let us check whether we can do the same with eq(9.76b). As a consequence of eq(9.69), we can write:

$$\mathbf{n}_s = \mathbf{N} \cdot \mathbf{n}_r + \mathbf{n}_0, \quad \tilde{\mu}_s = \mathbf{M} \cdot \tilde{\mu}_r \quad (9.77)$$

where \mathbf{n}_0 is the integration constant. Unfortunately, due to the singularity of \mathbf{N} , we cannot determine initial conditions for \mathbf{n}_r which are consistent with the given initial conditions of \mathbf{n}_s , and consequently, \mathbf{n}_0 cannot be normalized to zero. One possible assignment would be to normalize all initial conditions of \mathbf{n}_r to zero, and let the constant vector \mathbf{n}_0 equal the vector of initial conditions of \mathbf{n}_s :

$$\mathbf{n}_r(t = 0.0) = \mathbf{0.0}, \quad \mathbf{n}_0 = \mathbf{n}_s(t = 0.0) \quad (9.78)$$

As a consequence, eq(9.72) now becomes:

$$\dot{G} = \tilde{\mu}_s' \cdot \dot{\nu}_s + \tilde{\mu}_s'' \cdot \mathbf{n}_s = \tilde{\mu}_r' \cdot \dot{\nu}_r + \tilde{\mu}_r'' \cdot \mathbf{n}_r + \tilde{\mu}_s'' \cdot \mathbf{n}_0 \quad (9.79)$$

and therefore:

$$\tilde{\mu}_s'' \cdot \mathbf{n}_s \neq \tilde{\mu}_r'' \cdot \mathbf{n}_r \quad (9.80)$$

Unfortunately, we cannot decompose the second power balance equation into component reactions.

$$0.0 = T \cdot \dot{S}_{k_i} + \mu_{k_i} \cdot \nu_{k_i} \quad (9.81a)$$

$$\dot{p}_i \cdot V = \dot{\mu}_i \cdot \mathbf{n}_i \quad (9.81b)$$

We use eq(9.81a) to determine the partial entropy flow \dot{S}_{k_i} of the reaction k_i , and we use eq(9.81b) to determine the pressure change \dot{p}_i induced by the chemical substance i .

We replace eq(9.59) with:

$$p = \frac{\mathbf{n} \cdot R \cdot T}{V} \quad (9.59^{alt})$$

and therefore, eq(9.61) becomes:

$$\dot{P}_i = \frac{\nu_i \cdot R \cdot T}{V} \quad (9.61^{alt})$$

We can plug eq(9.81b) into eq(9.61^{alt}), and obtain:

$$\dot{\mu}_i = \frac{\dot{\nu}_i}{n_i} \cdot R \cdot T = \frac{\dot{z}_i}{z_i} \cdot R \cdot T \quad (9.82)$$

We shall use eq(9.82) to compute the chemical potentials. However, a small problem remains to be solved. Notice that eq(9.82) exhibits a *singularity* at $n_i = 0.0$, i.e., if we start out with an unexisting product which is to be generated during the chemical reaction, we run into numerical problems. Physically, this singularity signifies a discontinuity in the chemical potential. No matter has no chemical potential, but already the first molecule that is being generated comes with its own free energy of formation, thus, the chemical potential jumps from an arbitrarily set value of zero to its value of formation. Since we shall assign the free energy of formation as an initial condition to the chemical potential of the product species even before the first molecule of that species has been generated, we can ignore this discontinuity. Numerically, this is best done by adding a small number ϵ to the denominator. ϵ should be at least three to four orders of magnitude smaller than the expected number of moles of the product species.

In the isochoric case, the chemical potentials μ_i are no longer constant. Therefore, the chemical power will now be computed as follows:

$$P_{i,chem} = \dot{G}_i = \mu_i \cdot \nu_i + \dot{\mu}_i \cdot n_i \quad (9.83)$$

$P_{i,chem}$ is the power that flows into the CS element of the component gas i . The CS element is therefore now a two-port element.

Fig.9.2 shows the bond graph of the isothermic and isochoric hydrogen/bromine reaction:

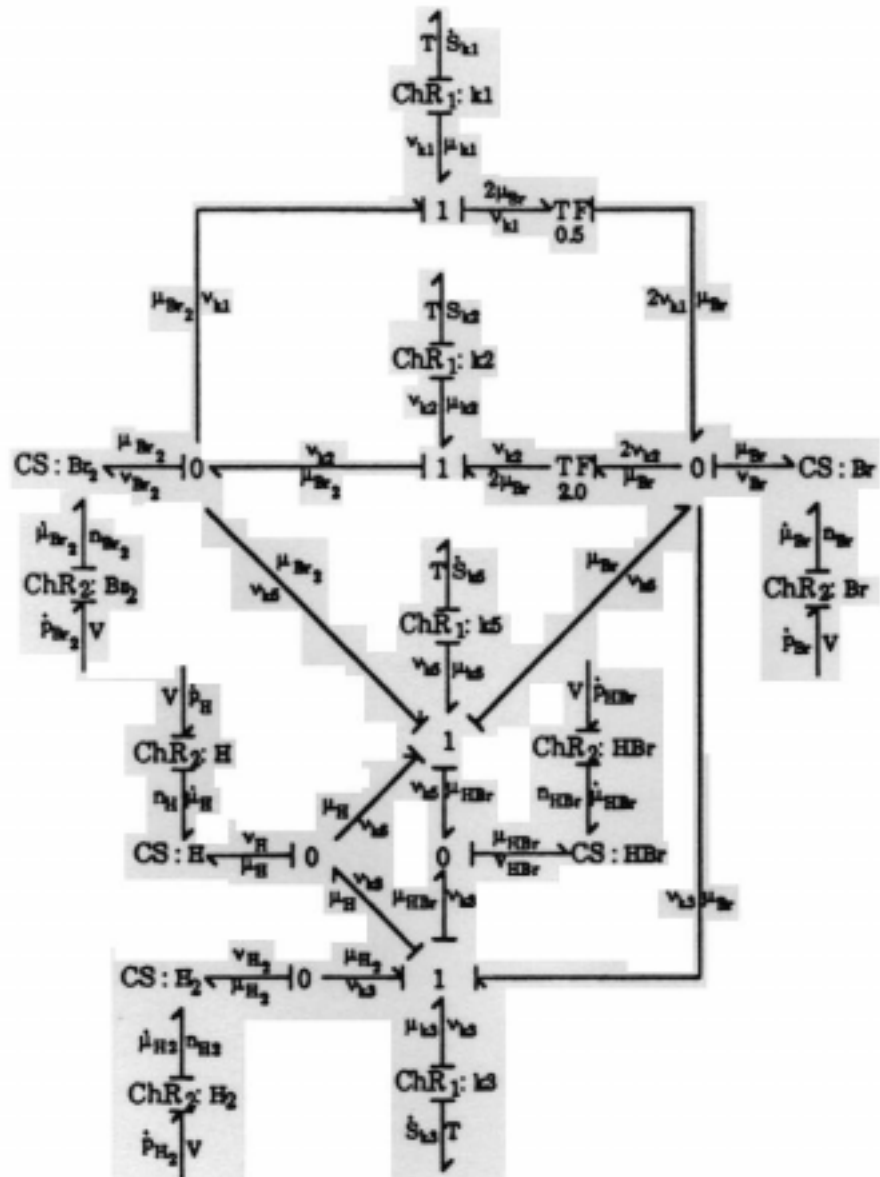

Figure 9.2. Bond graph of the isothermic and isochoric H_2-Br_2 reaction

Notice that the isochoric bond graph contains two separate CHR elements per reaction. The $CHR1$ element represents the first power balance equation eq(9.51a), and the $CHR2$ element represents the second power balance equation eq(9.51b). The isothermic and isobaric reaction was obviously a very special case. Since all $\dot{\mu}_i = 0.0$, the second power bond into the CS element was eliminated, and the n_i were computed directly inside the CS element.

The chemical reactor model $CHR1$ for the isothermic and isochoric hydrogen/bromine reaction k_3 can be coded as follows:

```
model type CHR1k3
  main cut chem1(mu*k3/-nu*k3),
  cut thermk3(Temp/-Sdotk3)
  terminal nH2, nBr, V
  parameter R = 8.314
  local k3
  k3 = (10 * 11.43) * exp(-82400/(R * Temp))
  0.0 = T * Sdotk3 + mu*k3 + nu*k3
  nu*k3 = k3 * nH2 * nBr/V
end
```

The chemical reactor model $CHR2$ for substance Br_2 can be coded as follows:

```
model type CHR2Br2
  main cut chem2(mu*dotBr2/-nBr2)
  cut pneu.Br2(pdot.Br2/V)
  terminal nu.Br2
  pdot.Br2 * V = mudot.Br2 * n.Br2
  der(n.Br2) = nu.Br2
end
```

The second chemical reactor imports the flow rate ν_{Br_2} as a modulation signal. The corresponding CS element can be coded as follows:

```
model type CS
  cut chem1(mu/nu), chem2(mudot/nu)
  terminal Temp
  parameter R = 8.314, eps = 1.0E-15
  mudot * (n + eps) = nu * R * Temp
  der(mu) = mudot
end
```

Again, the model is sufficiently simple, so that we can create a generic model type that will work for all CS elements.

The pneumatic model is replaced by:

```

model type Pneumatic
  main cut pneuTot(pdot/V)
  cut pneuBr2(pdotBr2/-), pneuBr(pdotBr/-)
  cut pneuH2(pdotH2/-), pneuH(pdotH/-)
  cut pneuHBr(pdotHBr/-)
  terminal p
  pdot = pdotBr2 + pdotBr + pdotH2 + pdotH + pdotHBr
  der(p) = pdot
end

```

The thermic model remains the same as before.

Let us discuss next what happens if we operate under the assumption of constant total entropy rather than constant temperature, i.e., if we operate under *isentropic* conditions rather than *isothermic* conditions. Let us discuss the combination of *isentropic* and *isobaric* conditions. This time, it is more practical to operate on *partial temperature flows* rather than the previously used partial entropy flows. "Partial temperatures" do not exactly represent a physical concept, but they work mathematically just fine. The power balance equations now turn into:

$$p \cdot \dot{q}_i = \dot{\mu}_i \cdot \nu_i \quad (9.84a)$$

$$0.0 = \dot{T}_i \cdot S + \dot{\mu}_i \cdot \nu_i \quad (9.84b)$$

In this case, the equation of state turns into:

$$p \cdot \dot{q}_i = \nu \cdot R \cdot T_i + n \cdot R \cdot \dot{T}_i \quad (9.85)$$

where n denotes the total number of moles, and μ denotes the total molar flow rate, or plugging in from eq(9.84a) this time expressed in terms of component substances:

$$\dot{\mu}_i \cdot \nu_i = \nu \cdot R \cdot T_i + n \cdot R \cdot \dot{T}_i \quad (9.86)$$

Expanding eq(9.86) with S , and plugging in eq(9.84b), we find:

$$\dot{\mu}_i \cdot \nu_i \cdot n \cdot R = \nu \cdot R \cdot T_i \cdot S - \dot{\mu}_i \cdot \nu_i \cdot S \quad (9.87)$$

Fig.9.3. illustrates such reactions by means of the bond graph of the isentropic and isobaric hydrogen/bromine reaction.

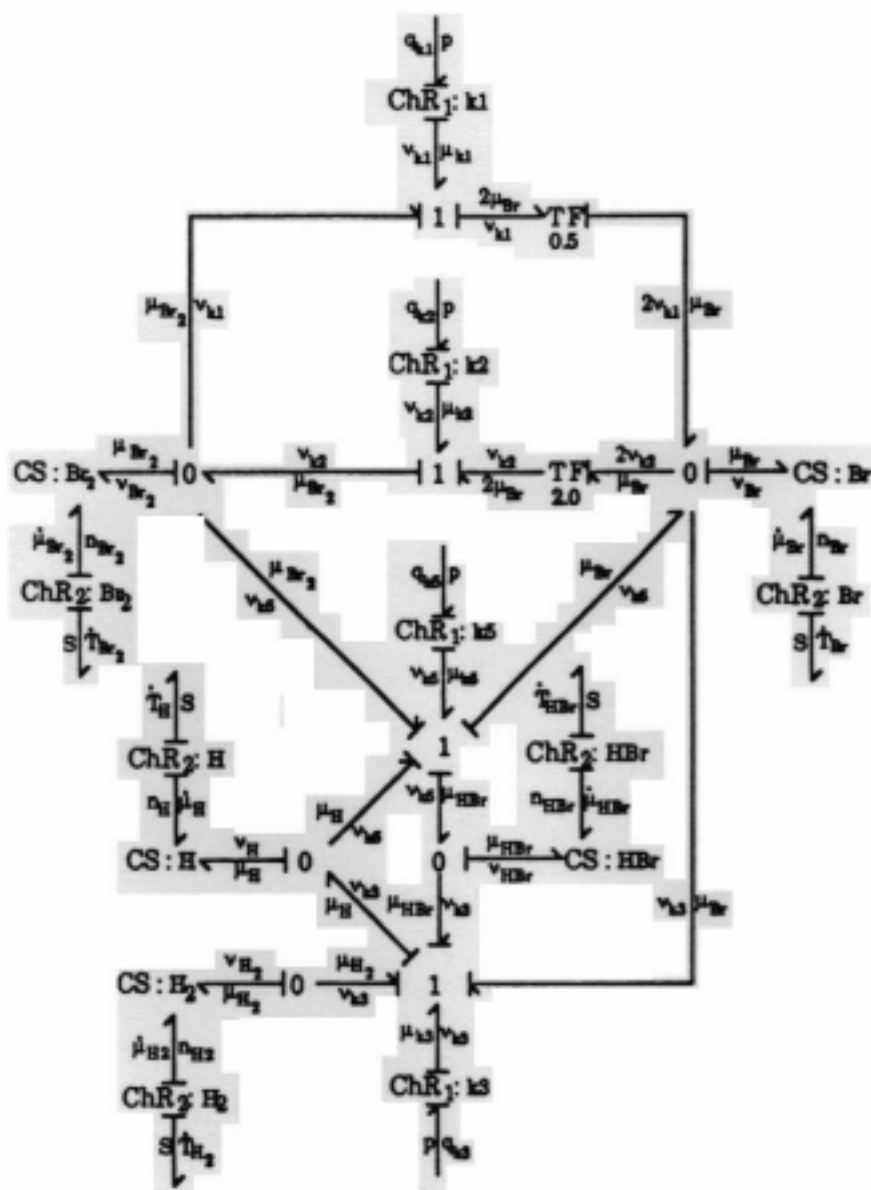

Figure 9.3. Bond graph of the isotropic and isobaric H_2-Br_2 reaction

The bond graph looks very similar to the previous one. Only the thermic and hydraulic/pneumatic ports have swapped positions. Let me write down the appropriate DYMOLA model types. The isobaric and isentropic *CHAR1* reactor for k_3 is now coded as follows:

```

model type CHAR1k3
  main cut chem1(mu*k3/-nu*k3)
  cut pneu*k3(p/q*k3)
  terminal nH2, nBr, V, Temp
  parameter R = 8.314
  local k3
  k3 = (10 * 11.43) * exp(-82400/(R * Temp))
  p * q*k3 = mu*k3 * nu*k3
  nu*k3 = k3 * nH2 * nBr/V
end

```

and the *CHAR2* reactor for Br_2 is coded as follows:

```

model type CHAR2Br2
  main cut chem2(mu*dotBr2/-nBr2)
  cut thermBr2(TdotBr2/-S)
  terminal nuBr2
  parameter eps = 1.0E-15
  0.0 = TdotBr2 * (S + eps) + mu*dotBr2 * nBr2
  der(nBr2) = nuBr2
end

```

The *CS* model type computes $\dot{\mu}$, from eq(9.87):

```

model type CS
  cut chem1(mu/nu), chem2(mu*dot/n)
  terminal Ttot, S, ntot, nutot
  local Temp
  parameter R = 8.314, eps = 1.0E-15
  Temp = Ttot * n/ntot
  mu*dot * (n + eps) * ntot * R = nutot * R * Temp * S - mu * nu * S
  der(mu) = mu*dot
end

```

We notice the same singularity problem as in the isothermic and isochoric case. The pneumatic model type is the same as for the isothermic and isobaric case. The thermic model looks now as follows:

```

model type Thermic
  main cut thermtot(Tdot/-S)
  cut thermBr2(TdotBr2/S), thermBr(TdotBr/S)
  cut thermH2(TdotH2/S), thermH(TdotH/S)
  cut thermHBr(TdotHBr/S)
  terminal Temp
  Tdot = TdotBr2 + TdotBr + TdotH2 + TdotH + TdotHBr
  der(Temp) = Tdot
end

```

This time, we need an additional global model that computes the total number of moles and the total molar flow:

```

model type Chemical
  terminal nuBr2, nuBr, nuH2, nuH, nuHBr
  terminal ntot, nutot
  nutot = nuBr2 + nuBr + nuH2 + nuH + nuHBr
  der(ntot) = nutot
end

```

The *chemical* model is not connected to the bond graph by means of power bonds, only by means of modulating signal paths.

The isentropic and isochoric case is more difficult. The first power balance equation turns into:

$$\sum_{w_i} \mu_i \cdot \nu_i = 0.0 \quad (9.88a)$$

which cannot be decomposed into individual components. Since the ν_i are computed from the reaction rate equations, at least one of the μ_i must be computed from eq(9.88a). However, since the other power balance equation now turns into:

$$\dot{p}_i \cdot V = \dot{T}_i \cdot S + \dot{\mu}_i \cdot n_i \quad (9.88b)$$

which references all $\dot{\mu}_i$, the set of equations is structurally singular.

Finally, if we assume that the reactions operate under complete thermic insulation, i.e., that the total thermic power adds up to zero, we call this an *adiabatic* reaction system. In an adiabatic reaction system, neither the temperature nor the entropy are constant. Instead, the external condition can be written as:

$$\sum_{w_i} (T \cdot \dot{S}_i + \dot{T} \cdot S_i) = 0.0 \quad (9.89)$$

Let us look at the adiabatic and isobaric reaction system. We decide to operate on partial entropy flows again. The power balance equations are thus written as:

$$p \cdot q_i = T \cdot \dot{S}_i + \mu_i \cdot \nu_i \quad (9.90a)$$

$$0.0 = \dot{T} \cdot S_i + \dot{\mu}_i \cdot n_i \quad (9.90b)$$

and the equation of state is written as:

$$p \cdot q_i = n_i \cdot R \cdot \dot{T} + \nu_i \cdot R \cdot T \quad (9.91)$$

Eq(9.89) can be used to compute \dot{T} , eq(9.90a) is used to compute \dot{S}_i , eq(9.90b) is used to determine $\dot{\mu}_i$, and eq(9.91) is used to find q_i . Unfortunately, this equation system contains a nasty algebraic loop which goes right across all the equations.

Let us discuss some additional properties of chemical reaction networks as they are exposed by the bond graph. Looking at the definitions for the reaction flow rates according to eq(9.26), it is obvious that the reaction flow rates can never be negative, and that they are zero only if one of the reactant populations has been exhausted. It is also clear that the Gibbs free energy (and therefore the chemical potential) of any chemical species is always positive except for $T = 0^\circ K$. Consequently, the chemical bonds in the chemical reaction bond graph describe correctly the direction of power flow through the network.

According to eq(9.67), the chemical potential of a reaction is defined as the balance between the sum of the chemical potentials of all products minus the sum of the chemical potentials of all reactants. Consequently, the chemical potential of a reaction can be either positive or negative. The chemical bonds that connect the chemical network with the two reactors do not necessarily represent the direction of power flow. A *spontaneous* reaction requires that $G_{\mathbf{a}_i} < 0.0$, and therefore, $\mu_{\mathbf{a}_i} < 0.0$. Consequently, spontaneous reactions occur "downhill", i.e., they take place if the sum of the chemical potentials of all products is smaller than the sum of the chemical potentials of all reactants.

According to eq(9.66), the flow rate of a chemical species is defined as the balance between the sum of the flow rates of all reactions that produce that species minus the sum of the flow rates of all reactions that consume the species. Consequently, also the chemical bonds that connect the chemical network with the capacitive source do not necessarily represent the direction of power flow. Chemical energy is being stored in the CS element of a given species whenever more of that species is produced than consumed, and it is being depleted otherwise.

9.6 Energies of Formation

Before we can solve our set of differential equations, we still need to discuss what the correct initial conditions are. The n_i , V_i , p_i , and T are easily measurable. The T_i from the isentropic and isobaric case can be easily determined from the equation:

$$\Delta H_{\text{R1}} = 3 \cdot H'_{\text{CO}_2} + 4 \cdot H'_{\text{H}_2\text{O}} - H'_{\text{C}_2\text{H}_6} \quad (9.97)$$

It is common to work with the normalized quantities, i.e. with *molar enthalpies of formation*:

$$\Delta \mathcal{H}_{\text{R1}} = 3 \cdot \mathcal{H}'_{\text{CO}_2} + 4 \cdot \mathcal{H}'_{\text{H}_2\text{O}} - \mathcal{H}'_{\text{C}_2\text{H}_6} \quad (9.98)$$

The molar enthalpy of formation of any pure substance depends on the temperature. The molar enthalpy of formation of a non-ideal gas depends furthermore on the gas pressure:

$$\mathcal{H}'_i = \mathcal{H}'_i(T, p) \quad (9.99)$$

Since $\mathcal{H}'_i(T, p)$ is a state function, i.e., it is independent of how the compound is being produced, we can “manufacture” the compound under “normal” conditions (such as $T = T_0 = 25^\circ\text{C}$, and $p = p_0 = 760 \text{ Torr}$), and then modify the temperature and the pressure of the already “manufactured” compound separately:

$$\mathcal{H}'_i(T_1, p_1) = \mathcal{H}'_i(T_0, p_0) + \int_{T_0}^{T_1} \frac{\partial \mathcal{H}'_i(T, p_0)}{\partial T} dT + \int_{p_0}^{p_1} \frac{\partial \mathcal{H}'_i(T_1, p)}{\partial p} dp \quad (9.100)$$

The constant term $\mathcal{H}'_i(T_0, p_0)$ is called the *standard molar enthalpy of formation* of the pure substance i . For most pure chemical substances, the standard molar enthalpies of formation have been tabulated and can be found in the literature, for example in Perry *et al.* [9.12] (Table 3-206).

The temperature correction term can be computed from the *heat capacity* of the substance since:

$$\frac{\partial \mathcal{H}'_i(T, p_0)}{\partial T} = c_{p,i}(T) \quad (9.101)$$

i.e., the partial derivative of the molar enthalpy with respect to temperature is the heat capacity $c_{p,i}$ of the pure substance i measured under the assumption of constant pressure. The heat capacity of pure substances depends on the temperature. In the vicinity of atmospheric pressure conditions, we can approximate the heat capacity through a quadratic polynomial:

$$c_{p,i}(T) = \alpha_i + \beta_i \cdot T + \gamma_i \cdot T^2 \quad (9.102)$$

The α_i , β_i , and γ_i coefficients have also been tabulated, at least for most pure gases. $c_{i,p}(T)$ changes abruptly at the transition from one phase to another, for example when going from the liquid phase to the gas phase. Therefore, eq(9.102) should not be used to integrate across a phase transition.

The pressure correction is only necessary for non-ideal gases. Correction terms have also been tabulated.

We are now able to compute the enthalpy of formation $H_i'(T, p)$ for most pure substances at arbitrary values of temperature and arbitrary values of pressure, and therefore, we can compute the reaction enthalpy for an arbitrary reaction. Notice that the reaction enthalpy does not appear explicitly in the reaction kinetics equations. However, it enters the reaction kinetics equations implicitly through the temperature dependence of the reaction rate constants. The enthalpy of formation will prove useful for the computation of the chemical potential. The chemical potential of the involved substances is needed to determine the chemical potential of the reaction. This in turn enables us to compute the excess/lacking chemical power needed to balance the total power of the reaction. This power, together with the equation of state, will determine the change in the thermic and hydraulic/pneumatic variables which finally influence the reaction rate constants.

I had mentioned before that, since chemical systems contain only one sort of chemical energy storage, the molar flow rate equations (the reaction kinetics equations) are decoupled from the equations that determine the chemical potential (the thermodynamics equations). However, this is only true as long as the chemical energy is considered in isolation. As soon as we couple the chemical model with the thermic and hydraulic/pneumatic models, additional energy storage elements enter the system, and this fact will create an indirect coupling between the equations that determine the flow rate and those that determine the potential.

A second property that we need to consider is the entropy of the system. We shall again use the normalized molar entropy. The entropy is another state function, thus we can use the same approach as for the enthalpy:

$$S_i'(T_1, p_1) = S_i'(T_0, p_0) + \int_{T_0}^{T_1} \frac{\partial S_i'(T, p_0)}{\partial T} dT + \int_{p_0}^{p_1} \frac{\partial S_i'(T_1, p)}{\partial p} dp \quad (9.103)$$

The entropy of any pure substance has been arbitrarily normalized to zero for $T = 0^\circ K$. Therefore, if we take T_0 to be zero, we can cancel the constant term $S_i^f(T_0, p_0)$ from eq(9.103). The second term can again be computed from the heat capacity since:

$$\frac{\partial S_i^f(T, p_0)}{\partial T} = \frac{c_{p,i}}{T} \quad (9.104)$$

Again, we have to be a little careful with phase transitions. Let us denote the melting temperature of a substance i with $T_{m,i}$, and the boiling temperature of that substance with $T_{b,i}$. In that case, we can compute the *molar entropy of formation* (which is sometimes called the *absolute entropy*) of gas i as follows:

$$S_i^f(T) = \int_0^{T_{m,i}} \frac{c_{p,i}}{T} dT + \frac{\Delta \mathcal{H}_{m,i}^f}{T_{m,i}} + \int_{T_{m,i}}^{T_{b,i}} \frac{c_{p,i}}{T} dT + \frac{\Delta \mathcal{H}_{b,i}^f}{T_{b,i}} + \int_{T_{b,i}}^T \frac{c_{p,i}}{T} dT \quad (9.105)$$

where $\Delta \mathcal{H}_{m,i}^f$ denotes the abrupt change of the molar enthalpy of formation from the solid to the liquid phase, and $\Delta \mathcal{H}_{b,i}^f$ denotes the abrupt change of the molar enthalpy of formation from the liquid to the gas phase.

We still need to discuss the third term. One of the *Maxwell relations* shows that:

$$\frac{\partial S}{\partial p} = -\frac{\partial V}{\partial T} \quad (9.106)$$

Let me prove the correctness of this relation. We have seen before that:

$$\dot{G} = -\dot{T} \cdot S + \dot{p} \cdot V + \sum_{w_i} \mu_i \cdot \nu_i \quad (9.45)$$

However, since we realize that $G = G(T, p, n_1, \dots, n_e)$, we can evaluate \dot{G} also from the complete differential:

$$\begin{aligned} dG &= \frac{\partial G}{\partial T} \cdot dT + \frac{\partial G}{\partial p} \cdot dp + \sum_{w_i} \left(\frac{\partial G}{\partial n_i} \cdot dn_i \right) \\ &= -S \cdot dT + V \cdot dp + \sum_{w_i} (\mu_i \cdot dn_i) \end{aligned} \quad (9.107)$$

A comparison of coefficients shows that:

$$\frac{\partial G}{\partial T} = -S \quad , \quad \frac{\partial G}{\partial p} = V \quad (9.108)$$

and therefore:

$$\frac{\partial}{\partial p} \left(\frac{\partial G}{\partial T} \right) = -\frac{\partial S}{\partial p} = \frac{\partial}{\partial T} \left(\frac{\partial G}{\partial p} \right) = \frac{\partial V}{\partial T} \quad (9.109)$$

as claimed above.

For an ideal gas, we can compute V from the equation of state eq(9.54), and thus:

$$\int_{p_0}^{p_1} \frac{\partial S_i^f(p)}{\partial p} dp = - \int_{p_0}^{p_1} \frac{\partial V_i(p)}{\partial T} dp = -n_i \cdot R \cdot \int_{p_0}^{p_1} \frac{1}{p} dp = -n_i \cdot R \cdot \log\left(\frac{p_1}{p_0}\right) \quad (9.110)$$

The normalized version of eq(9.110) looks as follows:

$$\Delta S_i^f(p) = -z_i \cdot R \cdot \log\left(\frac{p_1}{p_0}\right) \quad (9.111)$$

As in the case of the enthalpy, molar entropies of formation have been tabulated and can be found in the literature, usually for room temperature ($T = 25^\circ C$). The tabulated values contain only the temperature term, and not the pressure term.

Finally, let us look at the third energy function:

$$G_i^f = H_i^f - T \cdot S_i^f \quad (9.112)$$

G_i^f is the Gibbs free energy of formation of the pure substance i which is a measure of the chemical energy stored in the substance.

The normalized version of eq(9.112) can be written as:

$$G_i^f = \mathcal{H}_i^f - T \cdot S_i^f \quad (9.113)$$

Of course, there is no need to tabulate G_i^f if we have tables for \mathcal{H}_i^f and for S_i^f . Most references tabulate therefore only two of the three variables. Usually, the "enthalpy of formation" \mathcal{H}_i^f is tabulated, but while some references tabulate the "absolute entropy" S_i^f , others tabulate the "free energy" G_i^f .

The *chemical potential* of the pure substance i is just another name for its *molar Gibbs free energy of formation*. Using the above definitions, we find that:

$$\mu_i^f(T, p) = \mathcal{G}_i^f(T) + z_i \cdot R \cdot T \cdot \log\left(\frac{p}{p_0}\right) = \mathcal{H}_i^f(T) - T \cdot \mathcal{S}_i^f(T) + z_i \cdot R \cdot T \cdot \log\left(\frac{p}{p_0}\right) \quad (9.114)$$

where $\mathcal{G}_i^f(T)$ contains the tabulated constant values plus the temperature correction which is a function of the heat capacity. The logarithmic term stems from the pressure correction of the entropy. Notice that eq(9.114) is not in conflict with the second power balance equation for isothermic and isobaric reactions. Although μ_i^f is time varying (with z_i), the sum over all μ_i^f is still constant. However, if we choose the reference pressure p_0 to be identical with the operating pressure p , the time dependent term drops out of eq(9.114), and μ_i^f is indeed constant.

At this point, we have learned how to determine the chemical potential of any substance for arbitrary values of temperature and for arbitrary values of pressure. Under isothermic and isobaric conditions, the chemical potential μ_i is a constant.

The literature on chemical thermodynamics is unfortunately full of myths. The majority of references include in their formula for the chemical potential a term which is logarithmic in the mole fraction. This is justified for ideal gas reactions under isothermic and isochoric conditions where it is possible to integrate the differential equations for the μ_i explicitly. According to eq(9.82):

$$\dot{\mu}_i = \frac{\dot{z}_i}{z_i} \cdot R \cdot T \quad (9.82)$$

which can be integrated into:

$$\mu_i = \mu_i^f + (R \cdot T) \cdot \log(z_i) \quad (9.115)$$

However, this is a very special case. Most references suppress the information that eq(9.115) is only valid for isothermic and isochoric reactions among ideal gases. In our approach, we don't need to use eq(9.115), since we treat the thermal system dynamically, and can simply integrate the differential equations for μ_i . Our approach is thus much more general.

Most references derive eq(9.115) from one of the Maxwell relations, and therefore claim that it holds true for all ideal gases under arbitrary operation conditions. However, they use a partial derivative with respect to the pressure p in the derivation which doesn't make sense under isobaric conditions.

Notice that all the equations shown in this section are strictly steady-state equations. They should not be used as part of a dynamic simulation study, and indeed, we won't use them for such a purpose. However, we use them to determine initial conditions for the chemical potentials of the component species, and sometimes to determine initial conditions for their entropies. This is justified if we assume that the reaction to be simulated starts out from steady-state conditions. Once we have established the initial state, we don't use these equations any longer.

9.7 Continuous Reactors

Until now, we have discussed closed (autonomous) reaction systems. However, many chemical reactors are operated under conditions of constant inflow of reactants, and constant outflow of products, whereby the total volume inside the reactor remains constant.

The simplest continuous reactor is the *continuously stirred tank reactor* which is frequently abbreviated as *CSTR*. The CSTR can be modeled easily by adding flow sources to all 0-junctions in the reaction system. The flow sources represent the balance between inflow and outflow. Let us look at the simple reaction:



which is to describe an isothermic and isobaric reaction among three liquids. Since neither the pressure nor the volume will change, the hydraulic/pneumatic part of the reactor can be eliminated. We assume that a constant flow rate of liquid *A* is added to the system:

$$\nu_{A_{in}} = c = \text{constant} \quad (9.117)$$

Under the assumption of an ideal mixture of the three liquids, we can model the outflow through modulated flow sources. The amount of liquid of type *i* is proportional to its own mole fraction:

$$\nu_{i_{out}} = c \cdot \dot{z}_i = \frac{c \cdot \dot{n}_i}{n} \quad (9.118)$$

Therefore, the three flow sources can be modeled as follows:

$$\nu_{A_s} = c \cdot \left(\frac{n - n_A}{n} \right) \quad (9.119a)$$

$$\nu_{B_s} = -c \cdot \left(\frac{n_B}{n} \right) \quad (9.119b)$$

$$\nu_{C_s} = -c \cdot \left(\frac{n_C}{n} \right) \quad (9.119c)$$

Fig.9.4 shows the bond graph of the isothermic and isobaric CSTR.

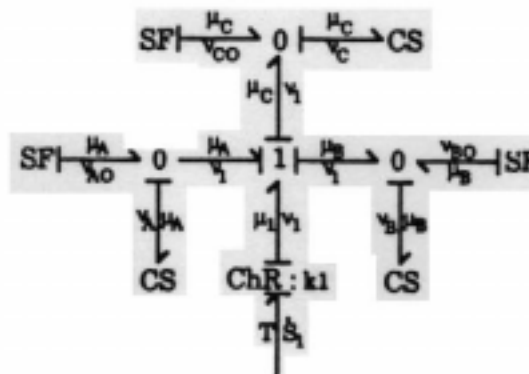

Figure 9.4. Bond graph of a simple CSTR reaction

The most commonly used reactors are the *fixed bed reactors*. Fluids are transported through a tube that is filled with gravel. The fluid reacts with the surface of the grains. This reactor type is much more complicated to model. The common approach is to compartmentalize the tubular reactor, i.e., cut it into pieces of length Δz . We want to assume that each compartment is homogeneous, i.e. the same temperature, entropy, pressure, volume, and chemical composition can be used throughout the compartment. For each compartment, we can set up a chemical reaction model similar to the one shown above. In addition, we need to model the heat flow through the tube using a diffusion model as presented in Chapter 8. The hydraulic/pneumatic system is modeled through wave equations with an additional friction term as shown in the research portion of Chapter 8. It is important to model each component fluid separately, since the compressibility and friction are different for each of them. Consequently, each chemical species moves through the tube with a different speed. This fact is being exploited by chemical engineers

in some of the common separation techniques, such as *thin layer chromatography* or *column chromatography*. These separation techniques sort the molecules either according to their *affinity* or to their *molecular sizes*. Both are dissipative phenomena. The *thermic* and *hydraulic/pneumatic* models are coupled through the *CHR* elements within each compartment. The volume flow can be used to compute the molar flow between the compartments. These molar flows will modulate flow sources which are attached to the 0-junctions, just as in the case of the CSTR. The modulated flow sources are now two-ports since the molar flow out of one compartment flows directly into the next, i.e., modulated flow sources are placed between each 0-junction of one compartment and the corresponding 0-junction of the next compartment.

Let us assume that a reactant *A* in an aqueous solution travels through the tubular reactor. The reactant *A* is decomposed in the reactor into the components *B* and *C*. Thus, further down the tube *A*, *B*, and *C* are mixed in the solution. Each of these components travels with a different speed. We have seen in Chapter 8, that the flow of a fluid through a tube can be described by the wave equation:

$$\frac{\partial^2 p}{\partial t^2} = c^2 \cdot \frac{\partial^2 p}{\partial x^2} \quad (9.120)$$

Eq(9.120) assumes that the friction of the fluid is negligible, while its compressibility is not negligible. Fig.9.5 shows a bond graph of the transport of a liquid through a tube.

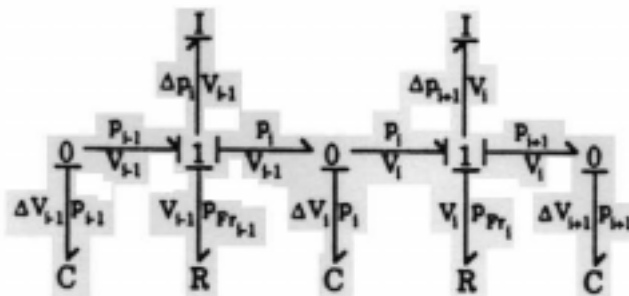

Figure 9.5. Bond graph of liquid transport through a tube

The wave equation assumes that friction effects are negligible. For our purposes, we don't want to make this assumption, since it is

precisely the friction which is responsible for the varying speed. The R elements in the bond graph model the friction (affinity) effects. We notice that this model contains two different energy storages. This seems to be in contradiction with our previous statement that the hydraulic/pneumatic energy is stored in a single (capacitive) container of the type $p \cdot V$. In the past, we assumed that the fluid was *stationary*. $p \cdot V$ is a structural energy storage which is part of the internal energy of the matter. However, now our fluid moves around. Therefore, the mechanical properties of the matter become important, i.e., the fluid carries both *potential energy* and *kinetic energy*. The C elements in the above bond graph store the potential energy $\frac{1}{2} \cdot C \cdot p^2$ of the fluid, whereas the I elements store the kinetic energy $\frac{1}{2} \cdot I \cdot q^2$ of the fluid.

How does the fluid transport equation interact with the chemical reaction model? Fig.9.6 shows an excerpt of the isothermic and isochoric bond graph of the above described reaction. Only two compartments, and only the A species are depicted.

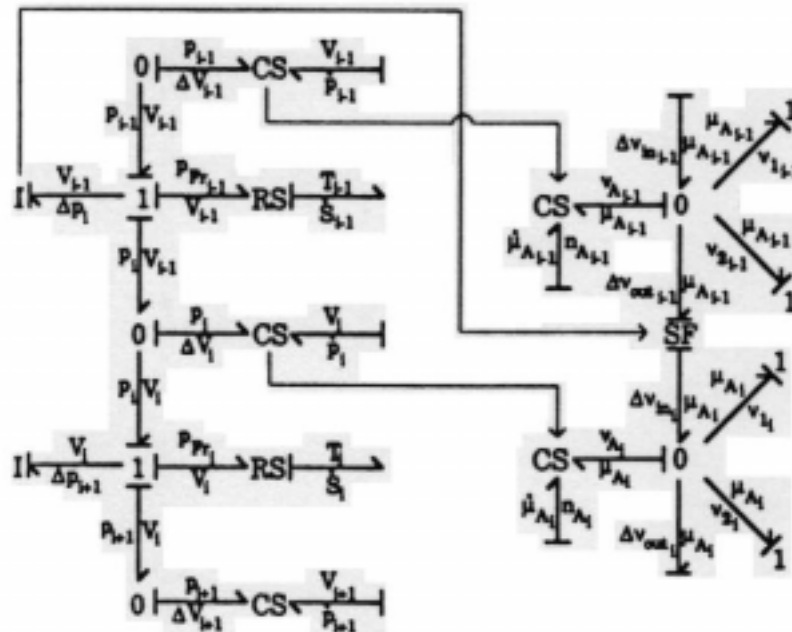

Figure 9.6. Excerpt of a bond graph of a tubular reactor

The *RS* element produces friction heat which is combined with the reaction heat in the thermic model. Also, we need a diffusion equation (not shown in the graph) which models the flow of heat through the system. The total heat produced in one compartment is split into a portion which is lost from the system (diffusion through the tubular walls), and another portion which is transported down to the next compartment.

The *C* element is now a *CS* element, since the change in the partial pressure of component *A* in the compartment *i* is now simultaneously caused by the potential energy of the fluid, and by the chemical reaction in the compartment:

$$\dot{p}_{A_i} = \frac{1}{C} \cdot \Delta V_{A_i} + \text{reaction term} \quad (9.121)$$

The partial pressure which is computed in the *CS* element of the transport model modulates the equation for the computation of $\dot{\mu}_{A_i}$ in the *CS* element of the reaction model.

The *I* element computes the volume flow rate q_{A_i} from which the molar flow rate $\Delta \nu_{A_i}$ can be derived. Thus, the *I* element of the transport model modulates the *SF* element of the reaction model.

If we model the flow of a pure liquid such as H_2O through a tube under isothermic conditions, we find that a fixed ratio exists between the volume of the liquid, and the number of moles, or between the volume flow rate and the molar flow rate:

$$n = r \cdot V \quad , \quad \nu = r \cdot q \quad (9.122)$$

However, from eq(9.81b), we find that:

$$\frac{n}{V} = \frac{\dot{p}}{\dot{\mu}} = r \quad (9.123)$$

and therefore:

$$p = r \cdot \mu + \text{constant} \quad (9.124)$$

where the integration constant can be normalized to zero. Consequently, the chemical variables μ and ν are related to the hydraulic variables p and V through a transformer. Therefore, we can write the wave equation in either hydraulic or chemical variables, i.e.:

$$\frac{\partial^2 p}{\partial t^2} = c^2 \cdot \frac{\partial^2 p}{\partial x^2} \quad , \quad \frac{\partial^2 q}{\partial t^2} = c^2 \cdot \frac{\partial^2 q}{\partial x^2} \quad (9.125a)$$

$$\frac{\partial^2 \mu}{\partial t^2} = c^2 \cdot \frac{\partial^2 \mu}{\partial x^2} \quad , \quad \frac{\partial^2 \nu}{\partial t^2} = c^2 \cdot \frac{\partial^2 \nu}{\partial x^2} \quad (9.125b)$$

Since water flows from a point of high pressure to a point of low pressure, and since, in the equilibrium state, all pressures are identical, the same holds true for the chemical variables. Molar flows within one species occur from a point of high chemical potential to a point of low chemical potential, and, in the equilibrium state, the chemical potentials of all molecules of the same species are equal.

Notice a possible point of confusion here. The term “molar flow” has now been used in two quite different contexts. On the one hand, it denotes the *physical transport* of matter from one point in space and time to another, while on the other hand, it also describes the *transformation* of one chemical species into another during a chemical reaction. For illustration purposes: The change per time unit in the number of plumbers in a community can be computed as the difference between the number of plumbers who move into the community minus those who move away (transport), plus the difference between the number of young adults who finish their education as plumbers minus the number of plumbers who die or decide to go for a career change (transformation).

The concept of matter flowing from a point of high chemical potential to a point of low chemical potential applies to both phenomena, i.e., matter “flows” (in both senses) “downhill” from points of high chemical potential to points of low chemical potential. In a true equilibrium, all chemical potentials would thus have to be constant and equal. However, the term “equilibrium” has been slightly generalized in the context of chemical reaction systems. We talk about a *chemical equilibrium state* when all molar flow rates ν_i into and out of the CS elements have died out, and when all chemical reaction potentials μ_k are zero, but this does not imply that the molar flow rates inside the chemical network (i.e., the reaction flow rates ν_{k_i}) have died out as well, nor does it imply that all chemical potentials of the species μ_i are equal. We call this generalized type of equilibrium the *equilibrium of flow*.

9.8 Photochemistry, Electrochemistry

We have seen that we can determine one thermal variable and one hydraulic/pneumatic variable externally, for example by externally controlling the reaction temperature, and by operating under atmospheric pressure conditions. In this way, we can manipulate the chemical potential and thereby the chemical energy, but we seem not to influence the flow rate equations at all. The flow rate equations were described as autonomous except for the volume influence mentioned earlier in this chapter. However, this is a simplification. It turns out that the reaction rate constants are strongly temperature dependent. Fig.9.7 shows the k_1 parameter of the hydrogen/bromine reaction plotted over temperature.

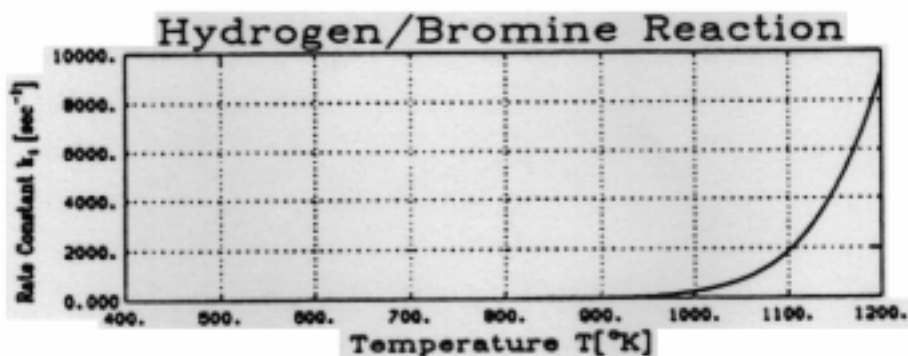

Figure 9.7. Temperature dependence of reaction rate constants

How can this be explained? Most reactions require an activation energy to occur, i.e., they need to pick up some energy before they can take place, even if they release more energy during the reaction than what they needed to pick up in the first place. Thus a reaction of the type:



will usually require activation energy since, otherwise, A would be a highly unstable species (unless it is being regenerated by another

simultaneously occurring reaction). Where does this activation energy come from? It stems from a collision with another molecule, i.e., the reaction of eq(9.116) should probably be rewritten as:



where M is a *catalyst* that is not further involved in the reaction except by shedding some of its own energy. Consequently, the k_1 reaction of the hydrogen/bromine system should be rewritten as:



where M can be anything, even another Br_2 molecule. The energy that can be shed most easily is the microscopic thermally induced kinetic energy of the molecules which increases with temperature. During a collision, the colliding molecules change their direction and speed. It is then easy for a molecule to steal some of the kinetic energy of the colliding partner and transform it into the required activation energy. Thus, reaction rate constants always grow with increasing temperature.

Let us replot Fig.9.7 using a double logarithmic scale:

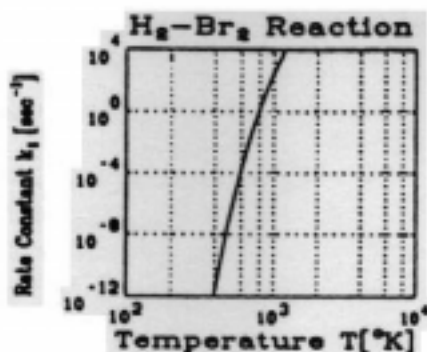

Figure 9.7^{alt}. Temperature dependence of reaction rate constants

We notice the almost linear relation between $\log(k_1)$ and $\log(T)$. On the basis of this experimental observation, Arrhenius formulated the following law for reaction rate constants:

$$k = A \cdot \exp\left(-\frac{E_a}{R \cdot T}\right) \quad (9.127)$$

where A is the *frequency factor* (denoting the frequency of collisions between molecules), and E_a is the activation energy. The collision frequency is also temperature dependent. More modern treatises have refined the *Arrhenius law* in the following way:

$$k = k_0 \cdot T^m \cdot \exp\left(-\frac{E_a}{R \cdot T}\right) \quad (9.127^{alt})$$

where m is a real number anywhere between 0.0 and 4.0, often $m \approx 0.5$.

By changing the reaction temperature, we can therefore influence the reaction kinetics. At higher temperatures, all reactions are accelerated, reactions that were not possible at low temperature can suddenly take place if the collision among molecules has become sufficiently violent so that it can deliver the required activation energy. Since the temperature dependence of the reaction rate constants is different for the various k_i coefficients in a reaction system, even the equilibrium state can be influenced by a change in the reaction temperature. Detailed information on reaction rate coefficients and their temperature dependence can be found in Kerr and Moss [9.6].

Is temperature the only mechanism that we have at our disposal for influencing the reaction dynamics? It is logical that the collision frequency among gas molecules depends also on the gas pressure. However, since the exponential factor in the Arrhenius equation is the dominant factor, the pressure dependence is not usually explored.

However, other mechanisms can also provide the required activation energy. One such mechanism is *light*. From Fig.9.7, we see that Br_2 does not spontaneously decompose into Br^* at room temperature, but without any Br^* radicals, the other reactions cannot take place. This is what we observe when we keep the hydrogen/bromine mixture at room temperature in a dark closet. Yet, if we expose the gas mixture to the influence of light, a reaction takes place.

The energy content of one photon is $h \cdot \nu$, where h is the *Planck constant* $h = 6.625 \cdot 10^{-34} \text{ J sec}$, and ν is the frequency (color) of the light. Thus, optical power can be expressed as:

$$P_{opt} = (h\nu) \cdot I \quad (9.128)$$

where $h\nu$ is the optical across variable, and I is the optical through variable. I denotes the number of photons per time unit, i.e., the light intensity. Now, what happens physically when photons arrive at the hydrogen/bromine mixture? Two things happen: (i) the light is absorbed, and is eventually transformed into heat (radiation),

and (ii) the photons collide with the Br_2 molecules and provide the (small) activation energy necessary to separate the Br_2 molecule into two Br^* radicals. The energy balance occurs inside the CHR reactor, i.e., eq(9.51a) is now modified to:

$$p \cdot q + (h\nu) \cdot I = T \cdot \dot{S} + \sum_w \mu_w \cdot \nu_w \quad (9.129)$$

and the k_1 reaction is modified to:



and therefore:

$$\nu_{Br^*} = 2k_1 \cdot \left(\frac{n_{Br_2} \cdot n_M}{V} \right) + 2k_1' \cdot I \cdot n_{Br_2} + \dots \quad (9.131)$$

At room temperature, k_1 is almost zero, but k_1' is not zero.

Another mechanism through which chemical reactions can sometimes be influenced is an *electrical field*. Salts dissolve in aqueous solutions into individual ions, for example:

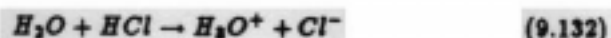

Ions are electrically charged, and they can therefore be separated through the application of an electrical field. If two metal plates are dipped into an ionised solution, and if an electrical field is created by connecting a voltage source to the two plates, we can observe that the positively charged ions migrate towards the cathode, while the negatively charged ions migrate towards the anode. This works even with pure water (but better with a drop of sulphuric acid H_2SO_4 or potash lye KOH added to it). In the water, an equilibrium exists between H_2O molecules on the one hand, and H_3O^+ and OH^- ions on the other. The acid or alkali will drastically enhance the number of ions in the solution. In the *electrolysis*, the following reactions take place:

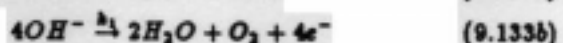
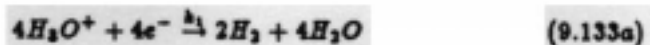

Reactions k_1 and k_2 are fast equilibrium reactions. The surplus electrons of eq(9.133b) wander from the anode through the voltage source back to the cathode where they are available for eq(9.133a). The acid or alkali acts as a catalyst, i.e., it does not participate itself in the reaction.

The energy balance occurs again inside the *CAR1* reactor, i.e., eq(9.51a) is now modified to:

$$p \cdot q = T \cdot \dot{S} + \sum_{\nu_i} \mu_i \cdot \nu_i + u \cdot i \quad (9.134)$$

The difference in the electrical potential between the two electrodes creates an electrical field. Since the ions are charged components, the field generates an electromotorical force which pulls the ions towards the electrodes. However, since the ions are dipoles, they themselves create a small electrical field which must first be overcome by the external field. Therefore, up to a given *built in voltage*, the applied voltage will only be able to polarize the ions. Only if a voltage is applied which is larger than the built in voltage, an actual transport of ions starts to occur. Due to various friction phenomena, an opposing force builds up during the transport which is proportional to the speed of the ions. In the steady-state, the two forces must balance each other out. Consequently, the speed (and therefore the reaction rate) is proportional to the applied voltage minus the built in voltage. The number of ions that arrive at the two electrodes is proportional to their traveling speed, and it is also proportional to the number of negatively charged ions. At the so-called *anode*, an *oxidation reaction* takes place in accordance with eq(9.133b), i.e. the surplus electrons are absorbed by the anode, and can travel through the voltage source to the so-called *cathode* where they are available for a *reduction reaction* in accordance with eq(9.133a). (Notice that the cathode is not necessarily the negative pole. By definition, the cathode is the electrode at which the reduction takes place, while the anode is the electrode at which the oxidation takes place.)

The electrically induced k_1 reaction flow rate can thus be computed as follows:

$$\nu_{el} = k_1 \cdot (u - u_0) \cdot n_{OH^-} \quad (9.135)$$

Eq(9.135) assumes a model of *homogeneously distributed ions*. In the electrolysis of water, this assumption is justified since new ion pairs are constantly produced in accordance with eq(9.133c). In other types of electrolysis, this assumption may be incorrect. Since the

electrical field is constant everywhere, all ions travel simultaneously with the same speed towards their attractor, and the region far away from the attracting electrode is soon depleted of one type of ions. Consequently, we may want to replace the current number of moles of donor ions in eq(9.135) by the initial number of moles of donor ions, and build in a discontinuity which resets ν_d to zero as soon as the donor ions have been exhausted.

9.9 Summary

In this chapter, we have demonstrated how the previously introduced modeling concepts can be employed to describe chemical reaction systems. It became clear that the bond graph approach to modeling supports the process of understanding the underlying physical phenomena significantly. DYMOLA proved to be a valuable tool for hierarchical and modular modeling of chemical reaction systems, far superior in flexibility and generality to previously used tools such as DYN SYL [9.11], LARKIN [9.4], or MACKSIM [9.2]. For the first time, we can hope to create a *chemical model library* from which modules can be picked more or less arbitrarily which can then be combined to make up complex systems, but a lot of research still needs to be done.

Many quite common chemical reactions are still poorly understood. Measurement techniques to determine experimentally the required model parameters are often inaccurate, and even more frequently unexisting. Impurities are the cause of large fluctuations in the behavior of real chemical reaction systems. These are just some of the problems that the chemical engineer is faced with in his or her everyday work. Yet, we are confident that this treatise presents a significant step forward in the mathematical description of chemical reaction kinetics.

Notice that our methodology avoided the distinction between *reversible thermodynamics* and *irreversible thermodynamics*. This dichotomy had to be introduced in earlier treatises because of the fact that these discussions all centered around the *thermodynamic steady-state* exclusively. In a steady-state analysis, it is important to distinguish between conservative (reversible) and dissipative (irreversible) phenomena, and the steady-state values do not preserve this information automatically. Therefore, it became important to

separate between them manually. However, this dichotomy is an artifact. If we describe the non-equilibrium thermodynamics through a bunch of differential equations, as we did in this chapter, the problem vanishes.

It can be noticed that our thermodynamic equations are quite a bit simpler and more compact than those found in most texts on thermodynamics. Again, this is a consequence of the dynamic vs the static approach. On a first glance, this seems counter-intuitive. Why should an approach which provides *more* information about the system result in *simpler* equations? This puzzle cannot be resolved without an understanding of the mechanisms of *complexity*. Let me, therefore, postpone an answer to this puzzle to the next chapter in which complexity will play a pertinent role.

I wish to acknowledge my gratitude to Peter Breedveld, Dean Karnopp, and Jean Thoma for their constructive criticisms of Chapters 7 to 9 of this text. Their comments were highly appreciated.

References

- [9.1] Ihsan Barin, Ottmar Knacke (1973), *Thermochemical Properties of Inorganic Substances*, Springer Verlag, Berlin.
- [9.2] Mike B. Carver, D. H. Hanley, and K. R. Chaplin (1978), *MAXSIM: Mass Action Chemical Kinetics Simulation User's Manual*, Report: AECL-6413, Atomic Energy of Canada, Ltd., Chalk River Nuclear Laboratories, Chalk River, Ontario, Canada.
- [9.3] John T. Davies (1950), "The Mechanism of Diffusion of Ions Across a Phase Boundary and Through Cell Walls", *J. Physical and Colloid Chemistry*, 54, pp. 185-204.
- [9.4] Peter Deuffhard, G. Bader, and U. Nowak (1980), *LARKIN — A Software Package for the Numerical Simulation of LARGE Systems Arising in Chemical Reaction KINETICS*, Report 100, University of Heidelberg, Institut für Angewandte Mathematik, Im Neuheimer Feld 293, D-6900 Heidelberg 1, FRG.
- [9.5] Frank C. Hoppensteadt, P. Alfeld, and Richard Aiken (1981), "Numerical Treatment of Rapid Chemical Kinetics by Perturbation and Projection Methods", in: *Modeling of Chemical Reaction Systems*, (Klaus H. Ebert, Peter Deuffhard, and Willi Jäger, eds.), Springer Verlag, Berlin, Series in Chemical Physics, 18, pp. 31-37.

- [9.6] J. Alistair Kerr, and Stephen J. Moss (1981), *Handbook of Bimolecular and Termolecular Gas Reactions*, CRC Press, Boca Raton, FL.
- [9.7] Joseph L. Latham (1962), *Elementary Reaction Kinetics*, Butterworth & Co., London, U.K.
- [9.8] Mark L. Levine, and Milan Bier (1990), "Electrophoretic Transport of Solutes in Aqueous Two-Phase Systems", submitted to *Electrophoresis*.
- [9.9] Bruce H. Mahan (1965), *University Chemistry*, Addison-Wesley, Reading, MA.
- [9.10] John W. Moore, Ralph G. Pearson, and Arthur A. Frost (1981), *Kinetics and Mechanism*, John Wiley & Sons, New York.
- [9.11] Gary K. Patterson, and R. B. Rossa (1978), *DYNSYL: A General-Purpose Dynamic Simulator for Chemical Processes*, Report: UCRL-52561, Lawrence Livermore Laboratory, Livermore, CA 94550.
- [9.12] Robert H. Perry, Don W. Green, and James O. Maloney (eds.) (1984), *Perry's Chemical Engineers' Handbook*, Sixth Edition, McGraw-Hill, New York.
- [9.13] Peter A. Rock (1983), *Chemical Thermodynamics*, University Science Books, Mill Valley, CA.
- [9.14] Terry Triffet, ed. (1989) *Automation of Extraterrestrial Systems for Oxygen Production*, Proceedings of the Workshop AESOP'89, La Jolla, CA, July 13-15, published by: University of Arizona Space Engineering Research Center, UA/NASA SERC, 4717 E. Ft. Lowell Rd., Tucson, AZ 85712.

Bibliography

- [B9.1] Guillermo J. Ferraudi (1988), *Elements of Inorganic Photochemistry*, John Wiley, New York.
- [B9.2] Jerry Goodisman (1987), *Electrochemistry: Theoretical Foundations, Quantum and Statistical Mechanics, Thermodynamics, the Solid State*, John Wiley, New York.
- [B9.3] Lasslo Kiss (1988), *Kinetics of Electrochemical Metal Dissolution*, Elsevier, Amsterdam, the Netherlands.
- [B9.4] Irving M. Klotz, and Robert M. Rosenberg (1986), *Chemical Thermodynamics: Basic Theory and Methods, Fourth Edition*, Benjamin/Cummings Publishing, Menlo Park, CA.
- [B9.5] Keith J. Laidler (1987), *Chemical Kinetics, Third Edition*, Harper & Row, New York.

- [B9.6] Harold Nicholson, ed. (1980), *Modelling of Dynamical Systems*, two volumes, Peter Peregrinus Ltd. Stevenage, U.K.
- [B9.7] George F. Oster, and Alan S. Perelson (1974), "Chemical Reaction Networks", *IEEE Trans. Circuits and Systems*, CAS-21(6), pp.709-721.
- [B9.8] Joseph M. Smith (1981), *Chemical Engineering Kinetics, Third Edition*, McGraw-Hill, New York.
- [B9.9] Jeffrey I. Steinfeld, Joseph S. Francisco, and William L. Hase (1989), *Chemical Kinetics and Dynamics*, Prentice-Hall, Englewood Cliffs, N.J.
- [B9.10] Jean Thoma (1976), "Simulation, Entropy Flux and Chemical Potential", *BioSystems*, 8, pp. 1-9.
- [B9.11] Jean Thoma, and Henri Atlan (1985), "Osmosis and Hydraulics by Network Thermodynamics and Bond Graphs", *J. Franklin Institute*, 319(1/2), pp. 217-226.

Homework Problems

[H9.1] Hydrogen Bromine Reaction

For the hydrogen bromine reaction described in this chapter, derive a set of differential equations which describe the dynamic behavior of the five species Br_2 , Br^\bullet , H_2 , HBr , and H^\bullet over time. Assume isothermic and isochoric conditions.

Moore and Pearson [9.10] gave the following experimental temperature characteristics for the five reaction rate constants:

$$k_1 = 1.39 \cdot 10^8 \cdot \sqrt{T} \cdot \left(\frac{189243.0}{R \cdot T}\right)^{1.87} \quad (H9.1a)$$

$$k_2 = ak_1 \cdot \exp\left(\frac{-189243.0}{R \cdot T}\right) \quad (H9.1b)$$

$$k_3 = \frac{k_1}{K(T)} \quad (H9.1c)$$

$$k_4 = 10^{11.43} \cdot \exp\left(\frac{-82400.0}{R \cdot T}\right) \quad (H9.1d)$$

$$k_5 = 10^{11.87} \cdot \exp\left(\frac{-149800.0}{R \cdot T}\right) \quad (H9.1e)$$

$$k_6 = 0.1 \cdot k_5 \quad (H9.1f)$$

where $R = 8.314 \text{ J } ^\circ\text{K}^{-1} \text{ mole}^{-1}$ is the gas constant, and $T = 800^\circ\text{K}$ is the absolute temperature measured in degrees Kelvins. The temperature dependence of the k_i coefficients of the hydrogen/bromine reaction were

[H9.2] Oxyhydrogen Gas Reaction

When oxygen and hydrogen gases are mixed in similar proportions, a spark can bring the mixture to explosion. We wish to describe this process. From the literature [9.5], it can be found that this process can be described by the following set of individual reactions:



where W stands for the wall. At the wall, the unstable atoms H^* and O^* , and the unstable radical OH^* can be absorbed. The absorption rates at the wall are strictly proportional to the concentrations of the absorbed species themselves, for example:

$$\frac{d}{dt} c_{OH^*} = -a_1 \cdot c_{OH^*} \quad (H9.2h)$$

The reaction rate constants given were as follows: $k_0 = 60.0$, $k_1 = 2.3 \cdot 10^{11}$, $k_2 = 4.02 \cdot 10^9$, $k_3 = 2.82 \cdot 10^{12}$, $a_1 = 920.0$, $a_2 = 80.0$, and $a_3 = 920.0$. The initial conditions are: $H_2 = 10^{-7}$, and $O_2 = 0.5 \cdot 10^{-7}$. The reference fails to specify for which temperature the given reaction rate constants are valid.

Generate a set of differential equations describing this system. Program your model in ACSL. Simulate the system over 0.1 sec. During the first 0.2 msec, use a communication interval of 10 μ sec, thereafter use a communication interval of 1 msec. Because of the inherent stiffness of the equations, use Gear's integration algorithm ($islg = 2$) with $nstp = 1001$. Because of the small numerical values of the concentrations, specify the absolute error (XERROR) for all state variables as 10^{-10} .

[H9.3] Isothermic and Isobaric Hydrogen/Bromine Reaction

Create a DYMOLA model that describes the total dynamics of the hydrogen/bromine reaction under the assumption of isothermic ($T = 800^\circ K$) and isobaric ($p = 1 \text{ atm}$) conditions. The initial reaction volume can be determined from the equation of state. The initial values of the total entropy and of the total free energy are arbitrarily set to zero (since we are only interested in the relative values: ΔS and ΔG of the reaction).

The constant μ_i values can be found from the literature. For this example, we find: $\mu_{Br_2} = -204493.0$, $\mu_{Br^*} = -53772.8$, $\mu_H = -129023.0$, $\mu_{H^*} = +106772.0$, and $\mu_{HBr} = -226828.0$.

Use the model types as described in this chapter, and connect the overall model according to the bond graph of Fig.9.1.

Simulate the system, and compare your results with those of hw(H9.1).

[H9.4] Isothermic and Isochoric Hydrogen/Bromine Reaction

Create a DYMOLA model that describes the total dynamics of the hydrogen/bromine reaction under the assumption of isothermic ($T = 800^\circ K$) and isochoric ($V = 10^{-3} m^3$) conditions. The initial pressure can be determined from the equation of state. The initial values of the total entropy and of the total free energy are arbitrarily set to zero (since we are only interested in the relative values: ΔS and ΔG of the reaction). The previously constant μ values are now used as initial conditions.

Replace the model types according to the description given in this chapter, enhance the bond graph by adding the missing chemical bonds for the $\dot{\mu}_i \cdot n_i$ terms.

Simulate the system, and compare your results with those of hw(H9.3).

[H9.5] Model Validation

We wish to validate the models of hw(H9.3) and hw(H9.4). For this purpose, we shall perform a number of experiments.

- (1) *Mass flow balance*: Since we operate under closed conditions, the total number of *Br* atoms and *H* atoms must remain constant at all times. Add equations to the models of hw(H9.3) and hw(H9.4) which compute (stoichiometrically) the total numbers of moles of the two types: n_{aH} and n_{aBr} . Verify that these numbers remain indeed constant during the simulation. This test helps you gain confidence in the accuracy of the numerical integration.
- (2) *Energy flow balance*: Since we operate under closed conditions, the total internal energy U of the reaction system must remain constant at all times. Add equations to the models of hw(H9.3) and hw(H9.4) which compute the internal energy U of the reaction systems, and verify that the internal energy remains indeed constant over time. This test is even better than the previous one, since the numerical value of U is more sensitive to numerical integration errors than the mass balance values n_{aH} and n_{aBr} .
- (3) *Steady-state conditions*: The steady-state numbers of moles of the five species can be analytically determined. We start out with the set of equations:

$$\frac{d}{dt}n_{B_2} = -\nu_{k1} + \nu_{k2} - \nu_{k3} \quad (H9.5a)$$

$$\frac{d}{dt}n_{B_2^*} = 2\nu_{k1} - 2\nu_{k2} - \nu_{k3} + \nu_{k4} + \nu_{k5} \quad (H9.5b)$$

$$\frac{d}{dt}n_{H_2} = -\nu_{k2} + \nu_{k4} \quad (H9.5c)$$

$$\frac{d}{dt}n_{H^*} = \nu_{k2} - \nu_{k4} - \nu_{k5} \quad (H9.5d)$$

$$\frac{d}{dt}n_{HB^*} = \nu_{k2} - \nu_{k4} + \nu_{k5} \quad (H9.5e)$$

and set all derivatives equal to zero. Since the N matrix of this reaction is singular, we cannot determine the steady-state (equilibrium of flow) values of all reaction flow rates. We obtain three equations for five unknowns. We replace the flow rates in these equations by their definition equations, eq(9.26), and obtain three highly non-linear equations in the five variables n_{B_2} , $n_{B_2^*}$, n_{H_2} , n_{H^*} , and n_{HB^*} . However, we can obtain the missing two equations from the knowledge that the final numbers of atoms of both types must be equal to the initial numbers of atoms of the two types. By solving this set of equations, we obtain a unique solution determining the steady-state numbers of moles of the five species. Verify that the steady-state values obtained from the simulations of hw(H9.3) and hw(H9.4) are in accordance with the theoretically found values. This test can unravel potential bugs in your reaction rate equations real fast.

- (5) **Total reaction energy:** Since we know the steady-state mass distribution, we can compute the enthalpies and free energies of formation before and after the reaction. We can then compute the total reaction energy ΔG produced or consumed during the reaction. Add equations to the two models of hw(H9.3) and hw(H9.4) which compute the reaction energy G as a function of time. Subtract the initial value of G (which was arbitrarily set equal to zero in the model) from the final value of G . This number should be the same as the theoretically found value of ΔG . This test detects potential bugs in your thermodynamics equations.

[H9.6] Boiling Water

Take 1 liter of water, and put it on your stove which you have previously heated up using the highest stove position. Start from room temperature, and measure the time that it takes to reach the boiling point. Continue to boil your water, and measure the time that it takes until no water is left in the pot.

Create a model that reproduces this experiment. Assume isentropic and isobaric conditions. Adjust the heat source in your model such that the time constants match those of the experiment. Notice that you have to take into account that you don't operate in a closed system. The evaporating water carries heat away which will keep the temperature from rising beyond the boiling point. What is the highest temperature that you will observe?

Repeat your modeling effort for a pressure cooker. This time, we assume isochoric conditions up to a pressure of $p = 2.5 \text{ atm}$. At this point, a pressure release valve will release some of the water vapor until the pressure is below a value of $p = 2 \text{ atm}$. Thereafter, the pressure starts building up again.

Solve manually the resulting structural singularity using one of the techniques proposed in Chapter 5. Simulate your isentropic and piecewise isochoric system. What is the highest water temperature that you will observe in this case?

[H9.7]* Rechargeable Battery

Rechargeable car batteries operate on the following principle: Two lead plates are dipped into a solution of sulphuric acid. During the electrolysis (i.e., the recharging process), the following reactions occur:

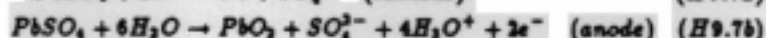
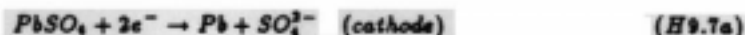

During the utilisation phase, the same reactions occur in opposite direction. When the battery is charged, metallic lead Pb builds up at the cathode, and brown lead dioxide PbO_2 builds up at the anode. When the battery is utilised, PbSO_4 goes into solution. If no lead dioxide is left on the anode, the battery is empty.

Unfortunately, this type of battery does not hold its charge very well over an extended period of time. Even without drawing current, the lead dioxide PbO_2 gets dissolved through a reaction with the lead of the plate itself:

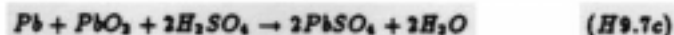

Another problem with this sort of battery is the following. A certain percentage of the lead sulphate PbSO_4 crystallises out, and can no longer be used for the oxidation/reduction process. If all sulphuric acid H_2SO_4 has been converted to crystalline lead sulphate PbSO_4 , the battery is dead.

The built in voltage of the rechargeable battery is $u_0 = 2.02 \text{ V}$. Place six such elements in series to get a 12 V battery. Create a DYMOLA model that represents the dynamics of the rechargeable battery. Simulate

a complete recharging/utilisation cycle. If the battery is initially empty, how long does it take to recharge it? Assume that you forgot to switch off your lights. How long does it take until the battery is empty?

Projects

[P9.1] Mining the Asteroids

The following description is extracted from the AESOP report [9.14]. It is due to Andy Cutler.

In future decades, it may be advantageous to extract oxygen from extraterrestrial sources such as lunar ilmenite or asteroidal chondrite. In this way, we may be able to produce propellant for interplanetary missions much more cheaply than by lifting it up from the gravity well of planet Earth.

Candidates for oxygen production in a low gravity environment are lunar or asteroidal rock. On the moon, a high concentration of ilmenite $FeTiO_3$ exists, in particular in the mares. The Mare Tranquillitatis consists of almost 50% of surface ilmenite that could be mined. The following reaction describes an oxygen reduction process in which ilmenite is reduced to iron Fe , to rutile TiO_2 , and to water vapor:

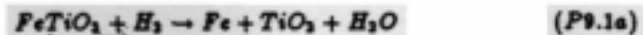

The hydrogen gas must be imported from Earth since the moon is very poor in hydrogen. However, in a second electrolysis stage, the water vapor can be reduced to oxygen gas and to hydrogen gas:



Thus, the hydrogen gas can be recovered, and can be recycled for reuse in the first stage. Therefore, the hydrogen import may not be as expensive as we might believe on first sight.

Similarly, many near Earth asteroids are likely to be rich in carbonaceous chondritic material. Water vapor can be extracted from such material in a pyrolysis stage. The water content of asteroidal chondrites is believed to be between 5% and 10%. Fig.P9.1 shows a chemical process which could be used for oxygen production from asteroidal chondritic material.

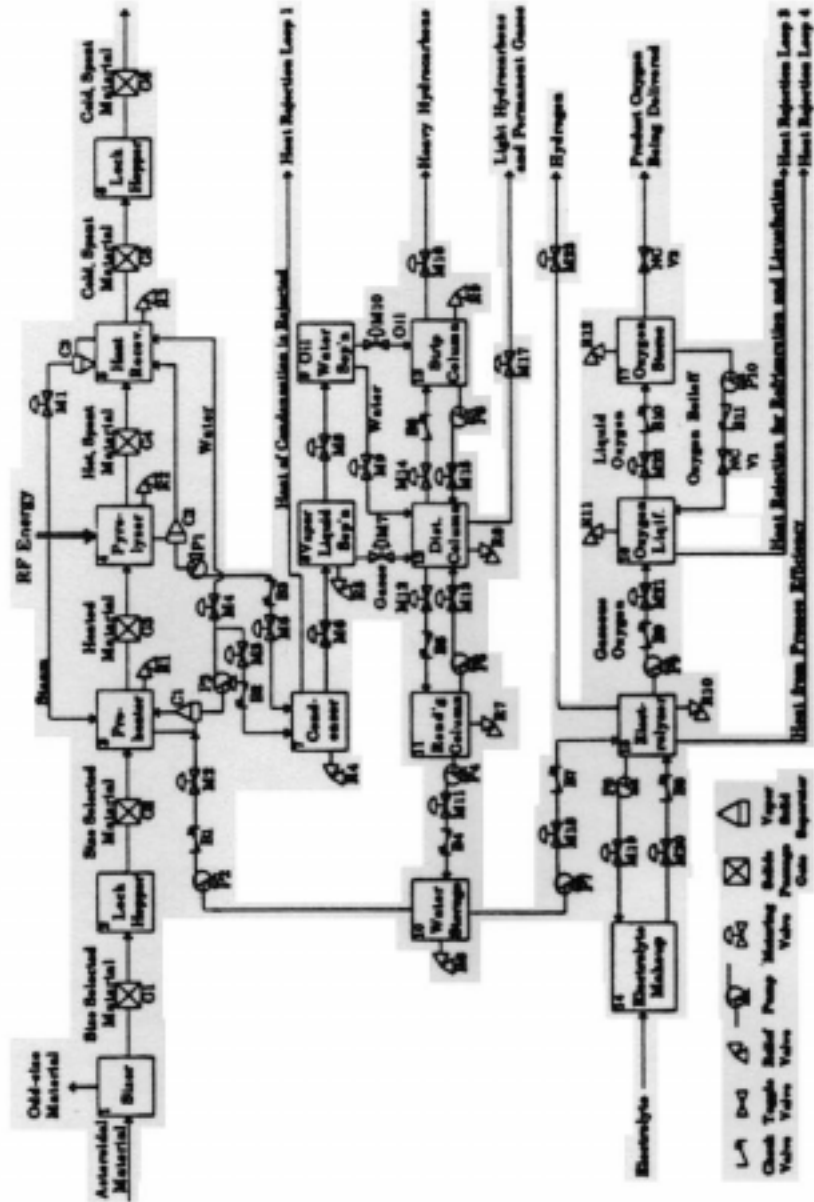

Figure P9.1. Process flow diagram for chondritic material pyrolysis

While such a flow diagram is fairly easy to generate, it does not provide us with precise quantitative information as to the rendition of oxygen, and as

to the total amount of energy that is being used up by the process. However, these two parameters will ultimately decide the economic attractiveness of the operation. Moreover, energy is a scarce resource in Space, and we need to plan ahead in order to determine what type of energy generation plant we must have if we wish to ensure the availability of the required amount of energy at all times. It is thereby not sufficient to be able to analyse the energy requirements under steady-state conditions, since we must install energy at the peak value. Consequently, we should be able to quantitatively model and simulate such a mining operation before it is ever built and deployed. The model should *simultaneously* explore the mass flow and the energy flow under dynamic conditions. Thus, the methodology that was introduced in this chapter seems to be the most suitable approach to tackling this problem.

Let me briefly explain how the process works that was depicted in Fig.P9.1. The sizer consists of a crusher which decomposes the rock mechanically, and a sieve which lets sufficiently small material pass, and reroutes larger pieces to the crusher for further decomposition. The material is then forwarded to an inlet *lock hopper* which accepts the presized material under vacuum, and forwards it to the *preheater* under pressure. The preheater brings the entire charge to a fixed temperature slightly below that at which pyrolysis begins to occur. The preheater is also responsible for controlling the gas pressure which may rise due to beginning evaporation of the charge. The *pyrolyzer* devolatilises the preheated feed by the addition of microwave heat. Rapid pressure control is important in order to keep the gas pressure inside the pyrolyzer within acceptable bounds at all times. The *heat recovery* stage is a heat exchanger which recovers a high percentage of the heat of the spent feed after pyrolysis. The temperature and pressure must be controlled carefully in order to recover as much heat as possible without condensing water vapor which would in the consequence be thrown out with the spent feed, and which would thereby be lost. The outlet *lock hopper* accepts the spent feed, and discharges it to the vacuum with little loss of the pressurised gas inside the system. This completes the description of the top row of Fig.P9.1.

The second row contains a *condenser* which pre-cools the pyrolysate vapor. A *vapor liquid separator* sends the remaining gases to the third row for further processing, and lets the liquid proceed to an *oil water separator*. Both products of the oil water separator are processed further in the third row. This completes the description of the second row.

The third row contains three columns (tubular reactors). The *distillation column* accepts the remaining gases and the impure water from the second row. It separates the material further. The heavy material ends up at the bottom, while the lightest material is at the top. The bottom will contain hydrocarbons which are fed to the *stripping column* for further processing. The top will contain gases which can either be disposed of or recycled for production of hydrogen. The medium portion of the distillation column

contains pre-purified water which is passed on to the rendering column for further purification. The stripping column is used to dewater the heavy hydrocarbons. The rendering column removes remaining heavy organic material from the pre-purified water. Its top product is pure water which is passed on to the water storage to await further processing. This completes the description of the third row.

The fourth and final row mixes the pure water with an electrolyte (such as potash lye *KOH*) for processing by the *electrolyser*. The electrolyte will invariably get contaminated by impurities in the water, and must therefore be periodically recycled to an *electrolyte makeup* chamber where the quality of the electrolyte is controlled and improved when needed. The electrolyser produces hydrogen which can either be burned off or recycled, and oxygen. In order to prevent losses of the oxygen product due to leakage, an *oxygen liquefier* is used which will convert the oxygen to a form that can more easily be stored in the *oxygen storage*. Oxygen which boils off is captured and rerouted to the oxygen liquefier. The heat which is produced in both the electrolysis and the oxygen refrigeration stage is also rerouted to the top column where it can be reused.

Create separate DYMOLA models for each of the boxes of Fig.P9.1. Connect the entire model, and simulate the mining operation. What is the peak value of energy that you must make available during the operation? What is the rendition of oxygen?

Research

[R9.1] Hierarchical Modular Model Library for Chemical Process Simulation

Build a library of DYMOLA model types for chemical reaction kinetics. The library should contain modules for all common reactor types, and it should be possible to solve problems such as pr(P9.1) by simply connecting the modules of the library with each other.

[R9.2] Electrophoretic Transport of Solutes in Aqueous Two-Phase Systems

Levine and Bier [9.8] reported recently a phenomena relating to the transport of proteins across a phase barrier under the influence of electrical fields in an electrophoretic setting. Proteins partition in aqueous two-phase systems as a result of differential affinities for the polymers. It turns out that proteins are readily transported across the phase barrier from low to high affinity, but they accumulate below the interface when electrically driven in the opposite direction. Surprisingly, the electrical field is not a sufficiently

strong force to overcome the thermodynamics of solute partitioning. The fact that electrophoretic transport as well as diffusion [9.3] can be influenced by the partitioning behavior of solute is of significance for the understanding of affinity, and it has direct relevance to biological systems with their many semipermeable and electrically charged membranes.

Levine and Bier believe that a full explanation of their experimental results will require an integration of kinetic terms governing electrophoretic transport with thermodynamic terms governing partitioning. It is hoped that the methodology derived in this chapter may provide us with such a tool.

Model the transport of proteins within individual phases, and compare the simulation results with experimentally found results. Thereafter, model the phase barrier in an aqueous two-phase system, and simulate the transport of proteins across this barrier. Include chemical, thermic, hydraulic, and electrical terms in the model. Compare your simulation results with the experimental results reported in Levine and Bier [9.8].