



Computational Photography and Video

Prof. Marc Pollefeys

Today's schedule

- Introduction of *Computational Photography*
- Course facts
- Syllabus
- Digital Photography

What is *computational photography*

- Convergence of image processing, computer vision, computer graphics and photography
- Digital photography:
 - Simply replaces traditional sensors and recording by digital technology
 - Involves only simple image processing
- Computational photography
 - More elaborate image manipulation, more computation
 - New types of media (panorama, 3D, etc.)
 - Camera design that take computation into account

Tone mapping

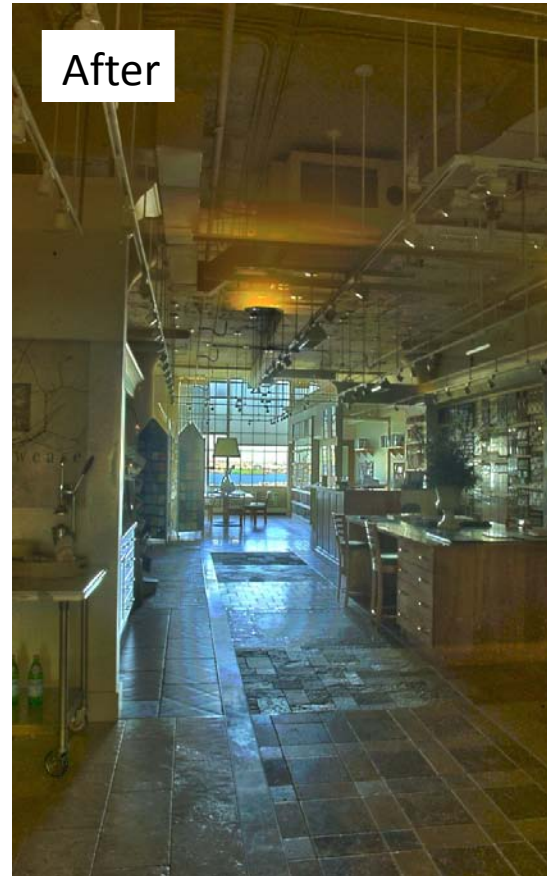

Flash/No-Flash

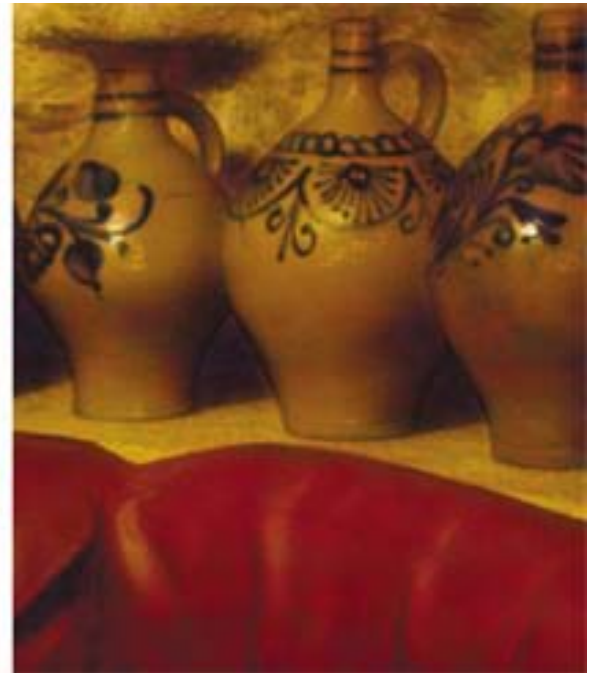

Photomontage



Panoramic images



Defocus matting

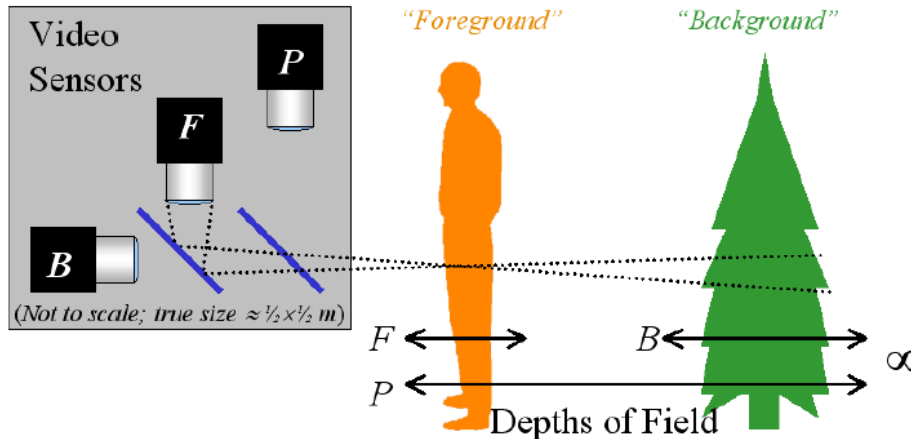
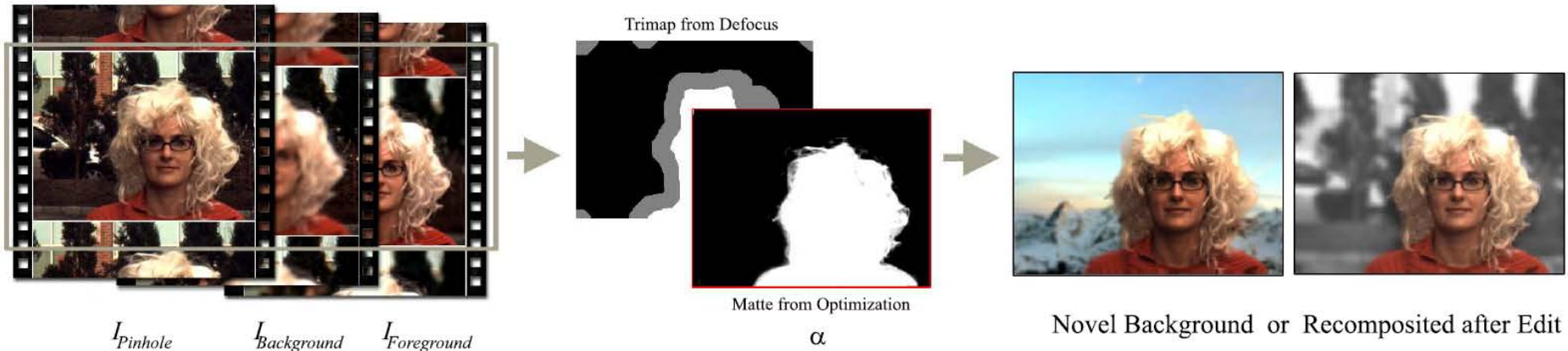

Coded Exposure Photography: Assisting Motion Deblurring using Fluttered Shutter

Raskar, Agrawal, Tumblin (Siggraph2006)

Short Exposure

Traditional

Coded

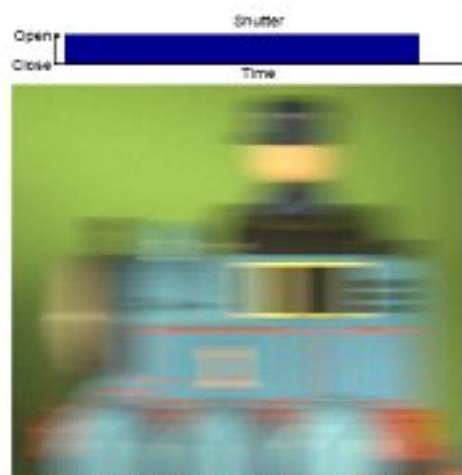
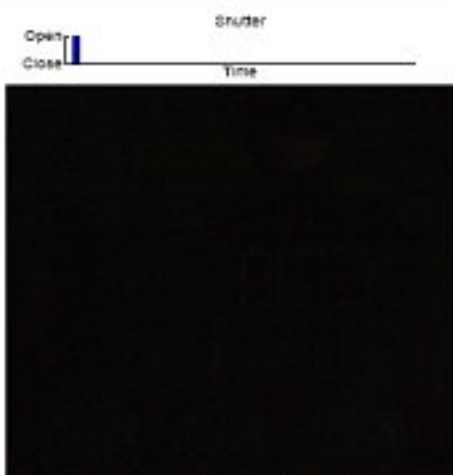

← Shutter →



← Captured Photos →



← Deblurred Results →



Image is dark and noisy

Result has Banding Artifacts and some spatial frequencies are lost

Decoded image is as good as image of a static scene

Video textures



Motion magnification



Today's schedule

- Introduction of *Computational Photography*
- Course facts
- Syllabus
- Digital Photography

Administrivia

- Staff
 - Prof. Marc Pollefeys
 - Dr. Kevin Koeser and Dr. Luca Ballan
- Time and location:
 - Lectures: Wednesday 13-15 in CAB G56
 - Exercises: Thursday 16-17 in CAB G56
- Webpage:

<http://www.inf.ethz.ch/personal/pomarc/courses/CompPhoto/>

Course organization

- Lectures
- Exercises
 - First a few assignments
 - Later project and paper presentations
- Small class project
 - Individual or small groups

Grading policy

- 50% assignments
- 10% paper presentation
- 40% class project (report + presentation)
- Bonus for participation

- No separate exam

Textbook

- No textbook required
- Slides available on course webpage
- Lot more resources online

- Interesting reference:

Computational Photography: Mastering New Techniques for Lenses, Lighting, and Sensors.
Raskar and Tumblin, to appear soon, A K Peters.

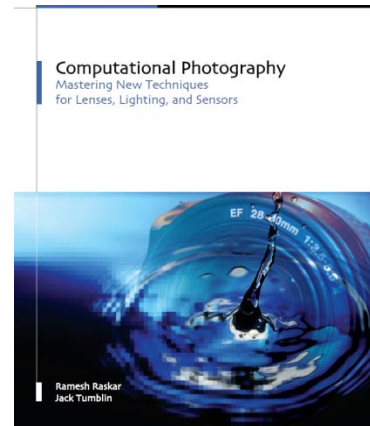

Today's schedule

- Introduction of *Computational Photography*
- Course facts
- Syllabus
- Digital Photography

Topics

- Image formation, Image sensor, Optics
- Pixel resolution, Exposure, Aperture, Focus, Dynamic Range
- Color, white balance, Bayer pattern, demosaicking, ...
- Motion blur, shutter, deblurring
- Dynamic range, HDR imaging, tone mapping, bilateral filtering
- Image pyramids, optical flow, gradients
- Matting and compositing, graphcuts
- Warping and morphing, panoramas
- Texture synthesis
- Illumination, flash/no-flash, depth edges
- Coded aperture, defocus
- Video textures, time-lapse, video summarization
- Lightfield imaging

Schedule	Computational Photography and Video	
24 Feb	Introduction to Computational Photography	
3 Mar	More on Camera,Sensors and Color	Assignment 1
10 Mar	Warping, Mosaics and Morphing	Assignment 2
17 Mar	Blending and compositing	Assignment 3
24 Mar	High-dynamic range	Assignment 4
31 Mar	<i>TBD</i>	Project proposals
7 Apr	<i>Easter holiday – no classes</i>	
14 Apr	<i>TBD</i>	Papers
21 Apr	<i>TBD</i>	Papers
28 Apr	<i>TBD</i>	Papers
5 May	<i>TBD</i>	Project update
12 May	<i>TBD</i>	Papers
19 May	<i>TBD</i>	Papers
26 May	<i>TBD</i>	Papers
2 June	Final project presentation	Final project presentation

Today's schedule

- Introduction of *Computational Photography*
- Course facts
- Syllabus
- Digital Photography

Overview

- Lens and viewpoint determine perspective
- Aperture and shutter speed determine exposure
- Aperture and other effects determine depth of field
- Sensor records image

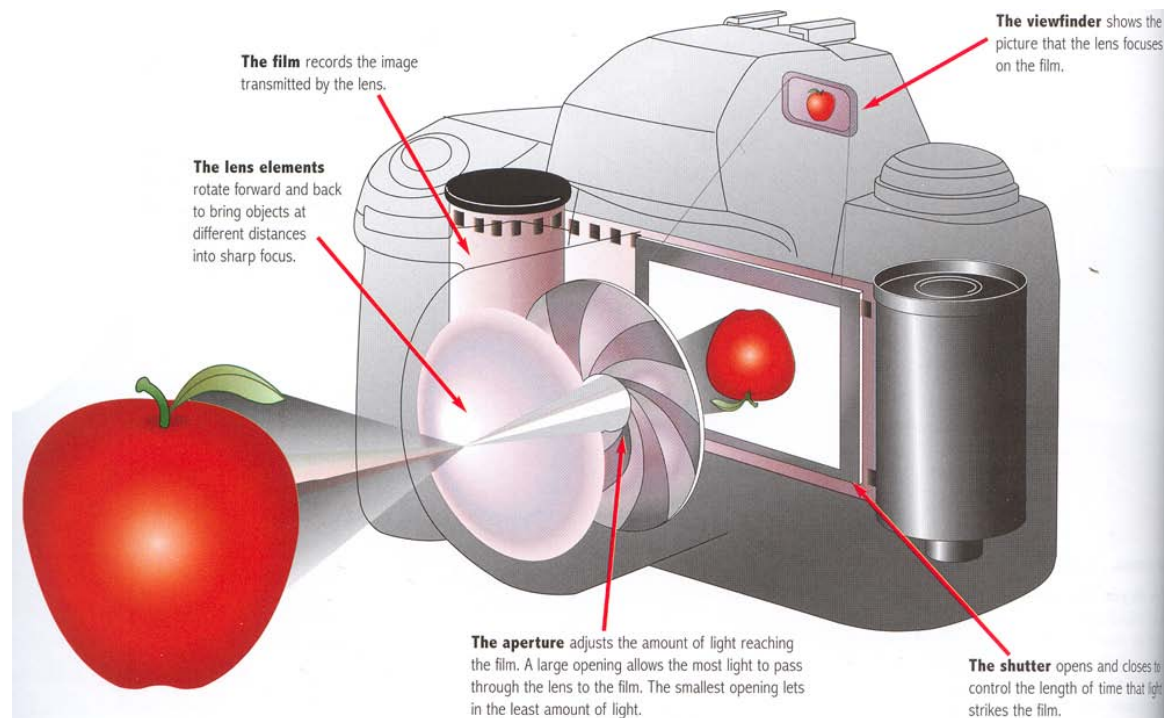

(this and following slides borrowed from Fredo Durand, MIT)

Reference

- [http://en.wikipedia.org/wiki/Lens_\(optics\)](http://en.wikipedia.org/wiki/Lens_(optics))

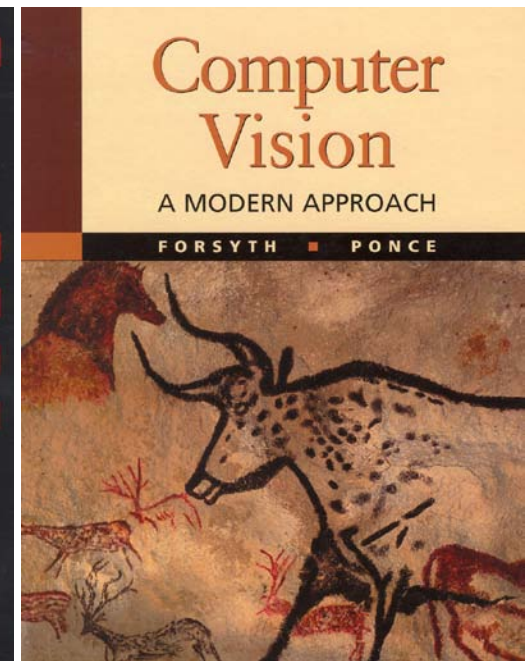
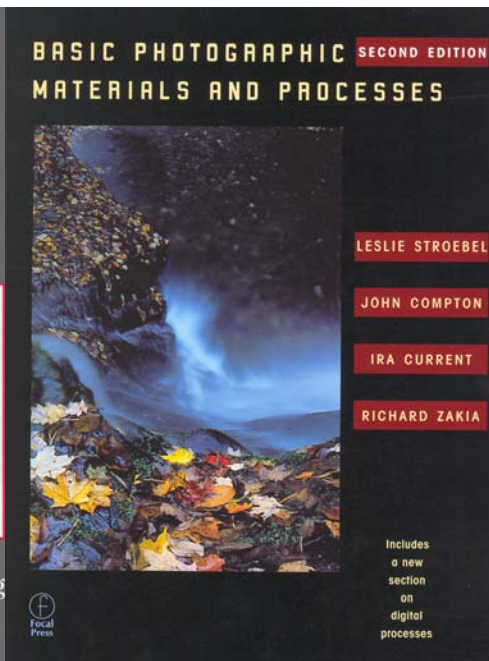
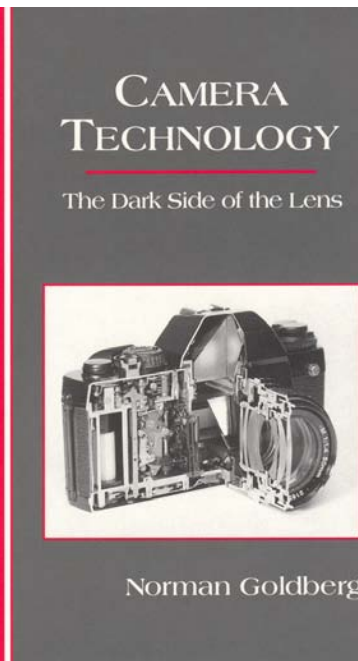
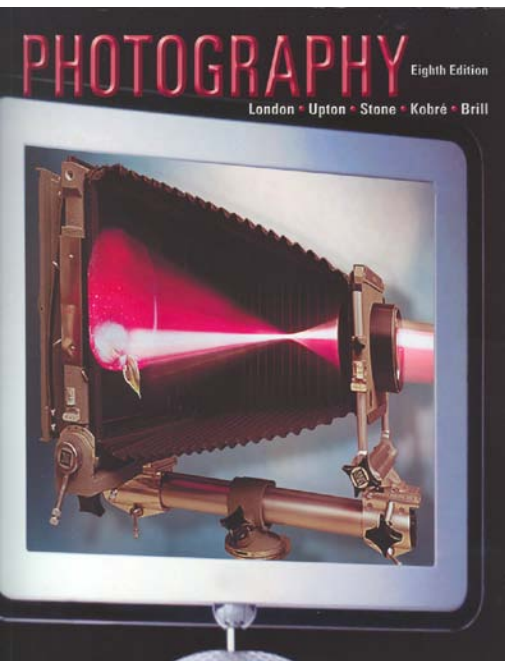

- The slides use illustrations from these books

More references

ANSEL ADAMS

The Camera

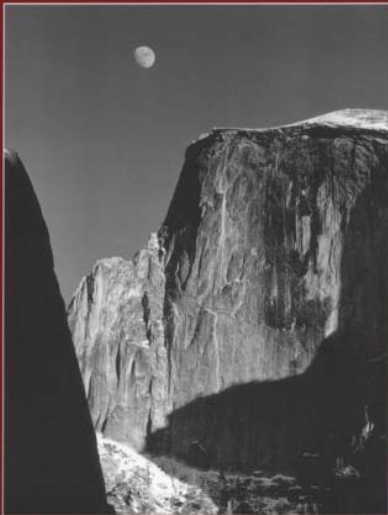

The Ansel Adams Photography Series 1

ANSEL ADAMS

The Negative



The Ansel Adams Photography Series 2

ANSEL ADAMS

The Print

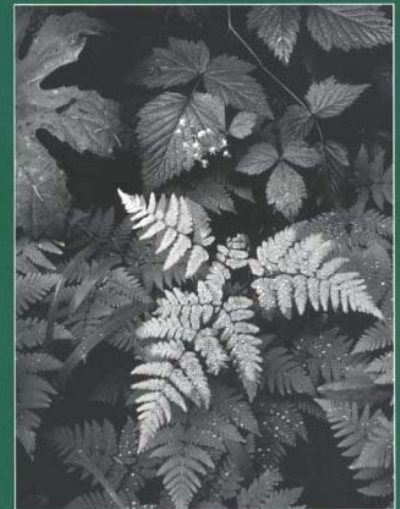

The Ansel Adams Photography Series 3

Plan

- Pinhole optics
- Lenses
- Exposure

Why is there no image on a white piece of paper?

- It receives light from all directions

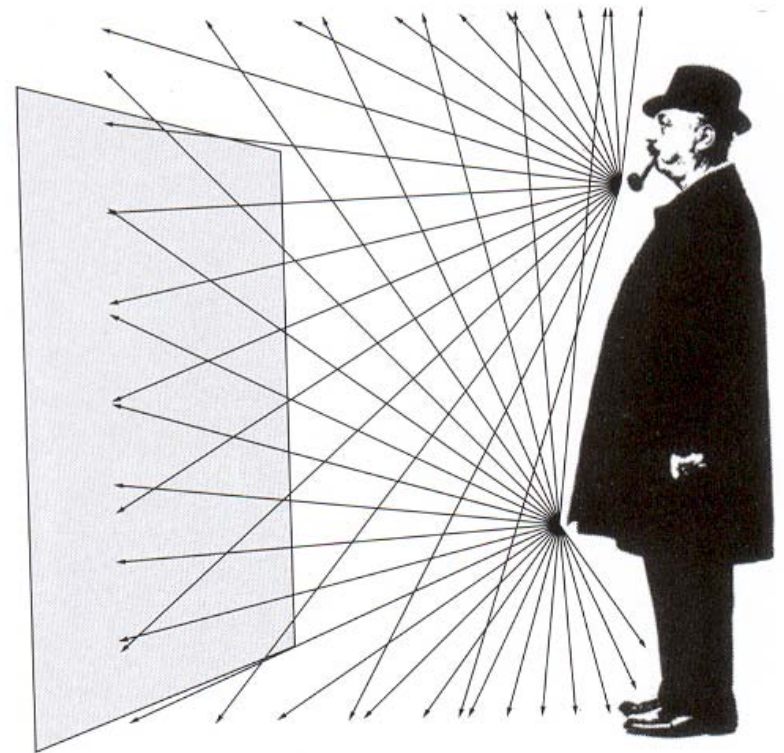

From Photography, London et al.

Pinhole

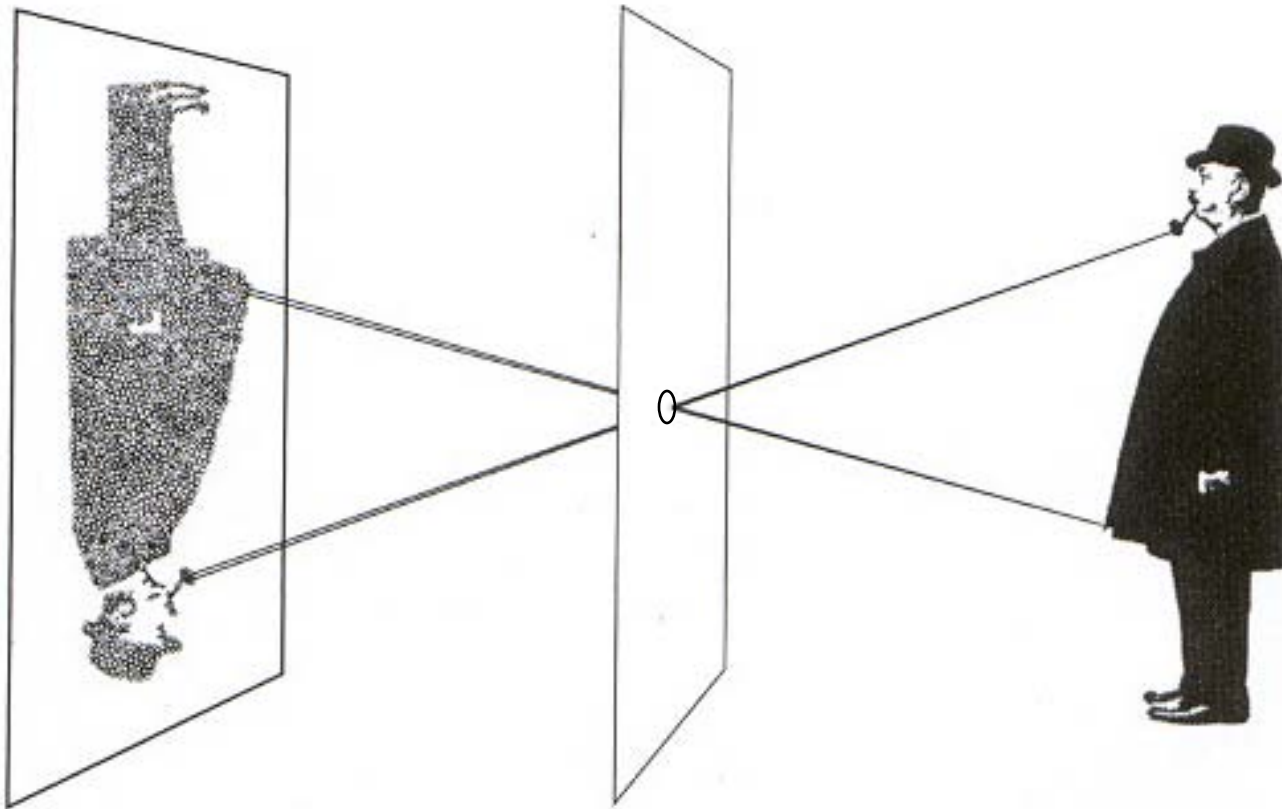

From Photography, London et al.

Focal length

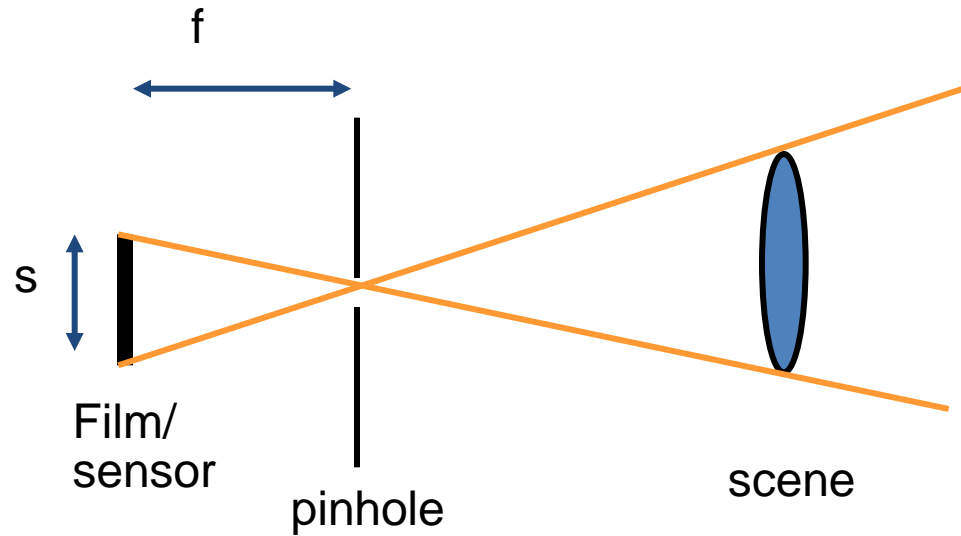

Focal length: pinhole optics

- What happens when the focal length is doubled?
 - Projected object size is doubled
 - Amount of light gathered is divided by 4

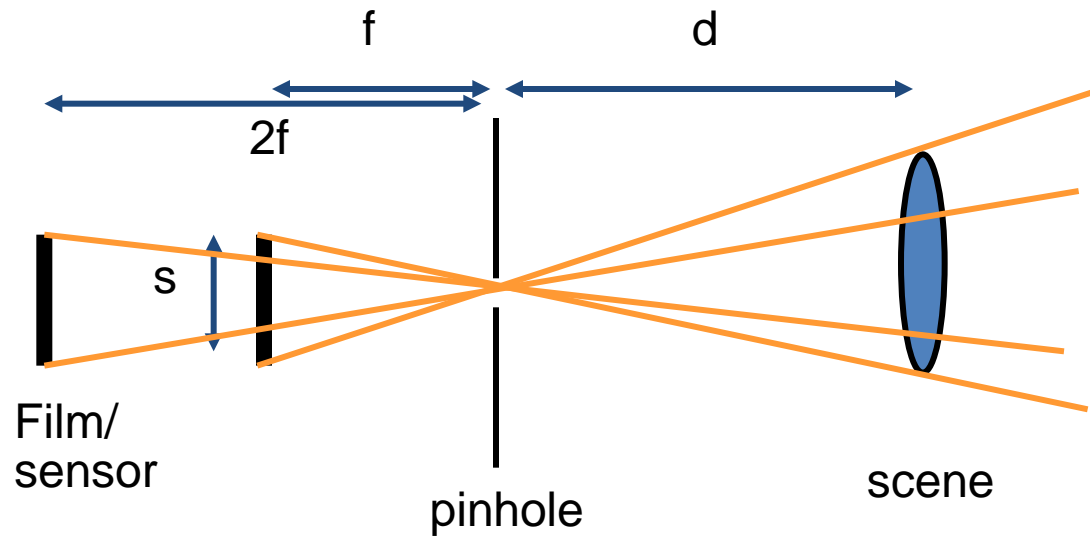

Questions?

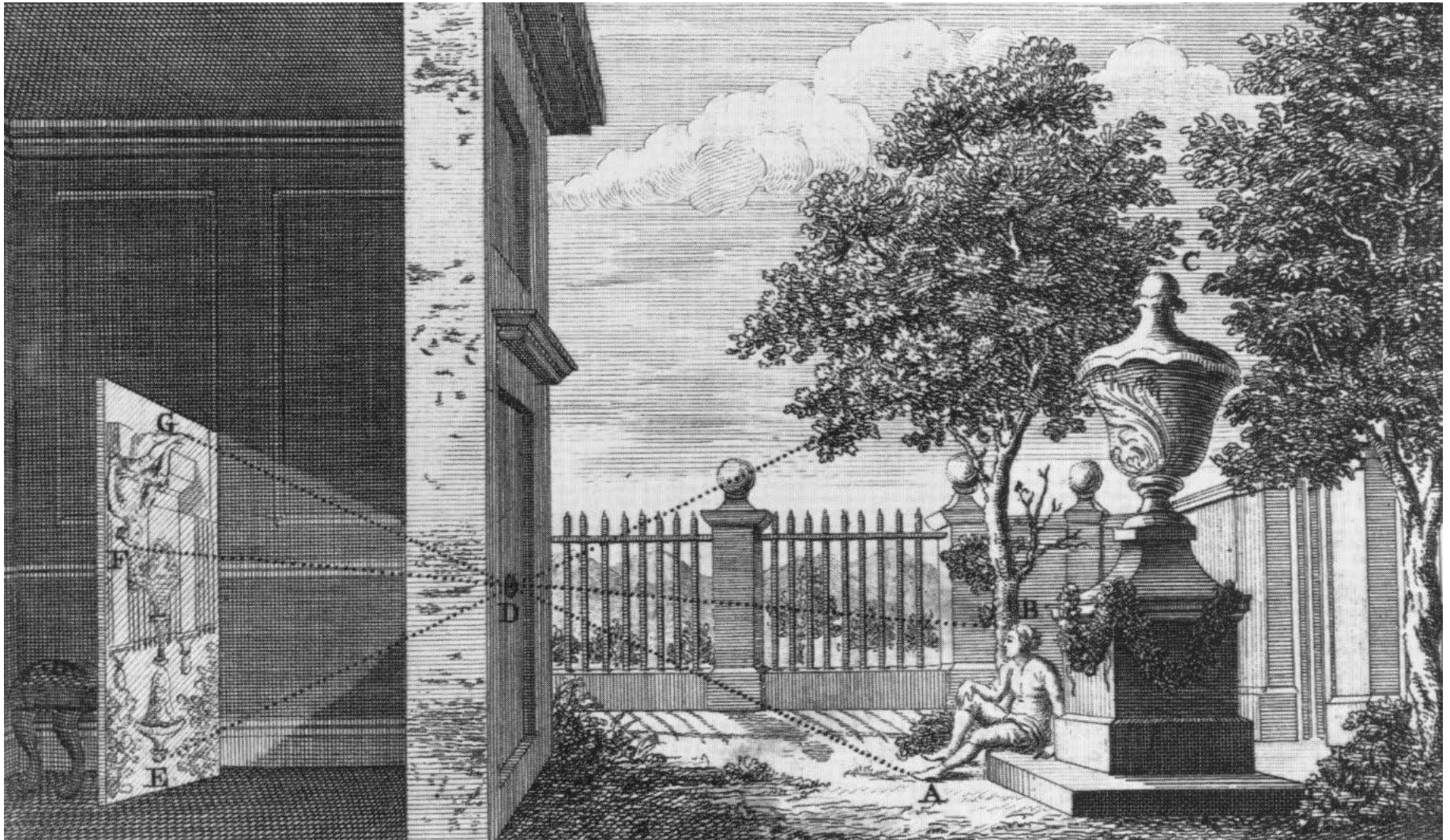

Pinhole size?

Photograph made with small pinhole

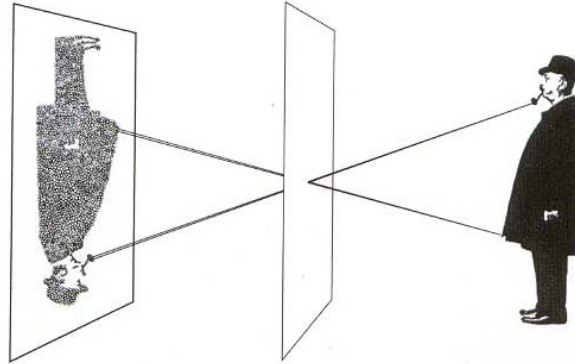

Photograph made with larger pinhole

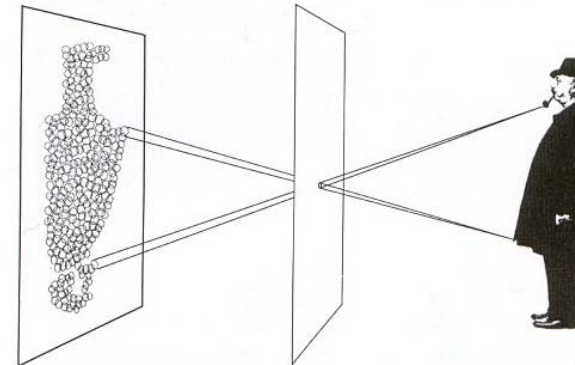
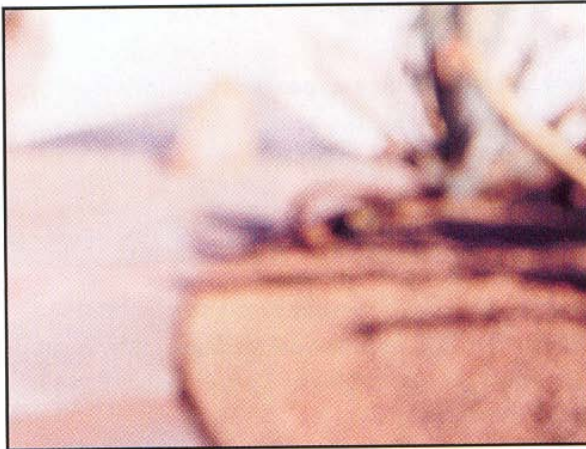

Diffraction limit

- Optimal size for visible light:
 $\sqrt{f}/28$ (in millimeters) where f is focal length

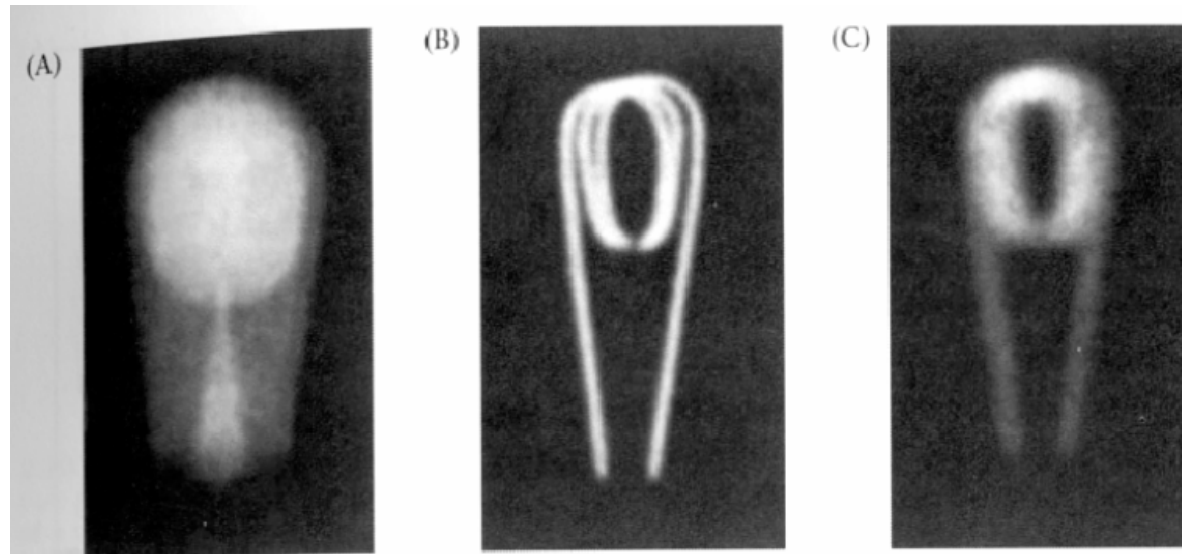

2.18 DIFFRACTION LIMITS THE QUALITY OF PINHOLE OPTICS. These three images of a bulb filament were made using pinholes with decreasing size. (A) When the pinhole is relatively large, the image rays are not properly converged, and the image is blurred. (B) Reducing the size of the pinhole improves the focus. (C) Reducing the size of the pinhole further worsens the focus, due to diffraction. From Ruechardt, 1958.

Problem with pinhole?

- Not enough light!
- Diffraction limits sharpness

Solution: refraction!

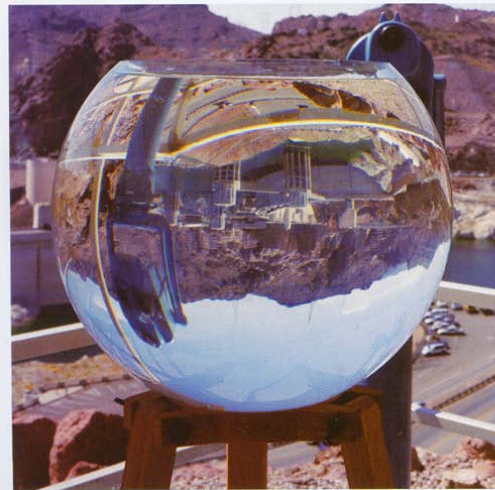
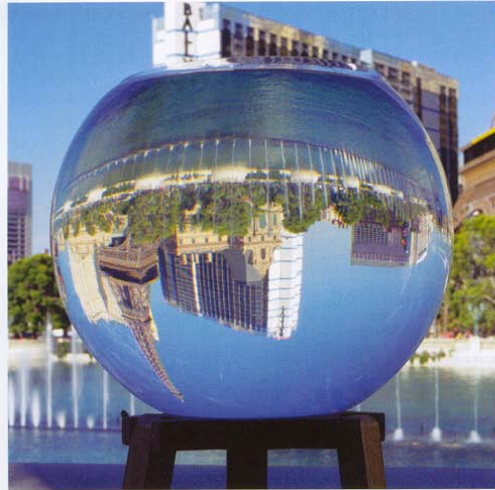

Photograph made with small pinhole

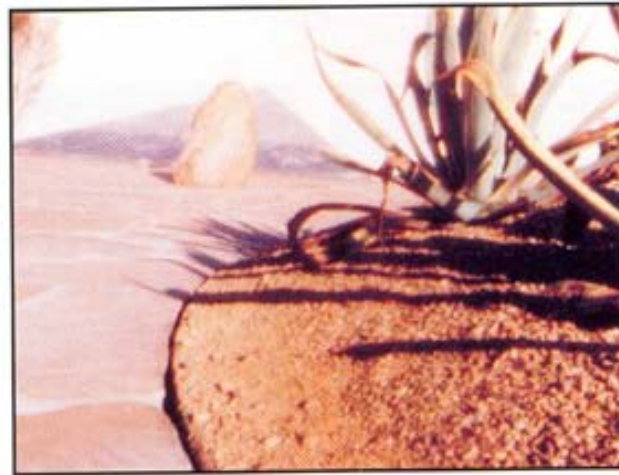

To make this picture, the lens of a camera was replaced with a thin metal disk pierced by a tiny pinhole, equivalent in size to an aperture of $f/182$. Only a few rays of light from each point on the

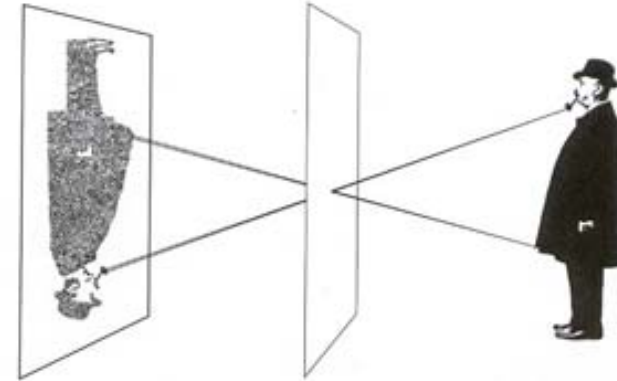

subject got through the tiny opening, producing a soft but acceptably clear photograph. Because of the small size of the pinhole, the exposure had to be 6 sec long.

- gather more light!
- But need to be focused

Photograph made with lens



This time, using a simple convex lens with an $f/16$ aperture, the scene appeared sharper than the one taken with the smaller pinhole, and the exposure time was much shorter, only 1/100 sec.

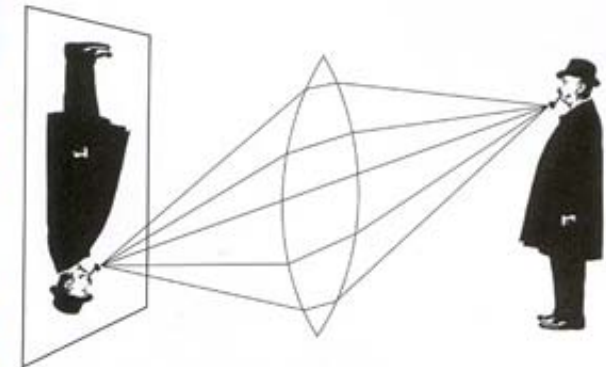

The lens opening was much bigger than the pinhole, letting in far more light, but it focused the rays from each point on the subject precisely so that they were sharp on the film.

Thin lens optics

- Simplification of geometrical optics for well-behaved lenses
- All parallel rays converge to one point on a plane located at the focal length f

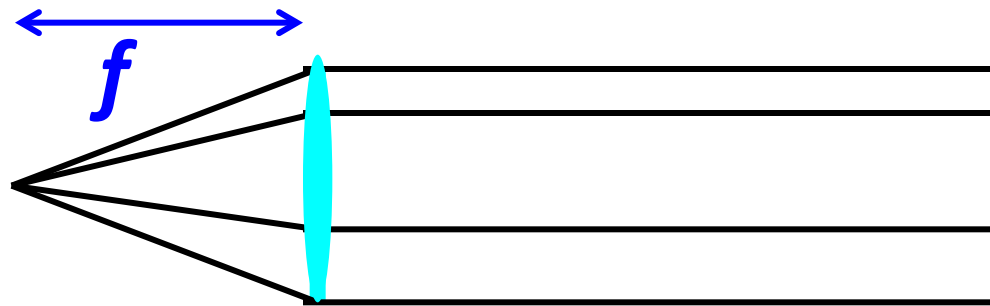

- All rays going through the center are not deviated
 - Hence same perspective as pinhole

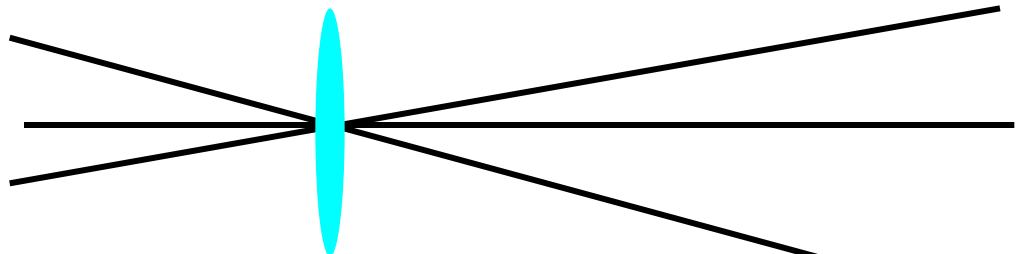

How to trace rays

- Start by rays through the center

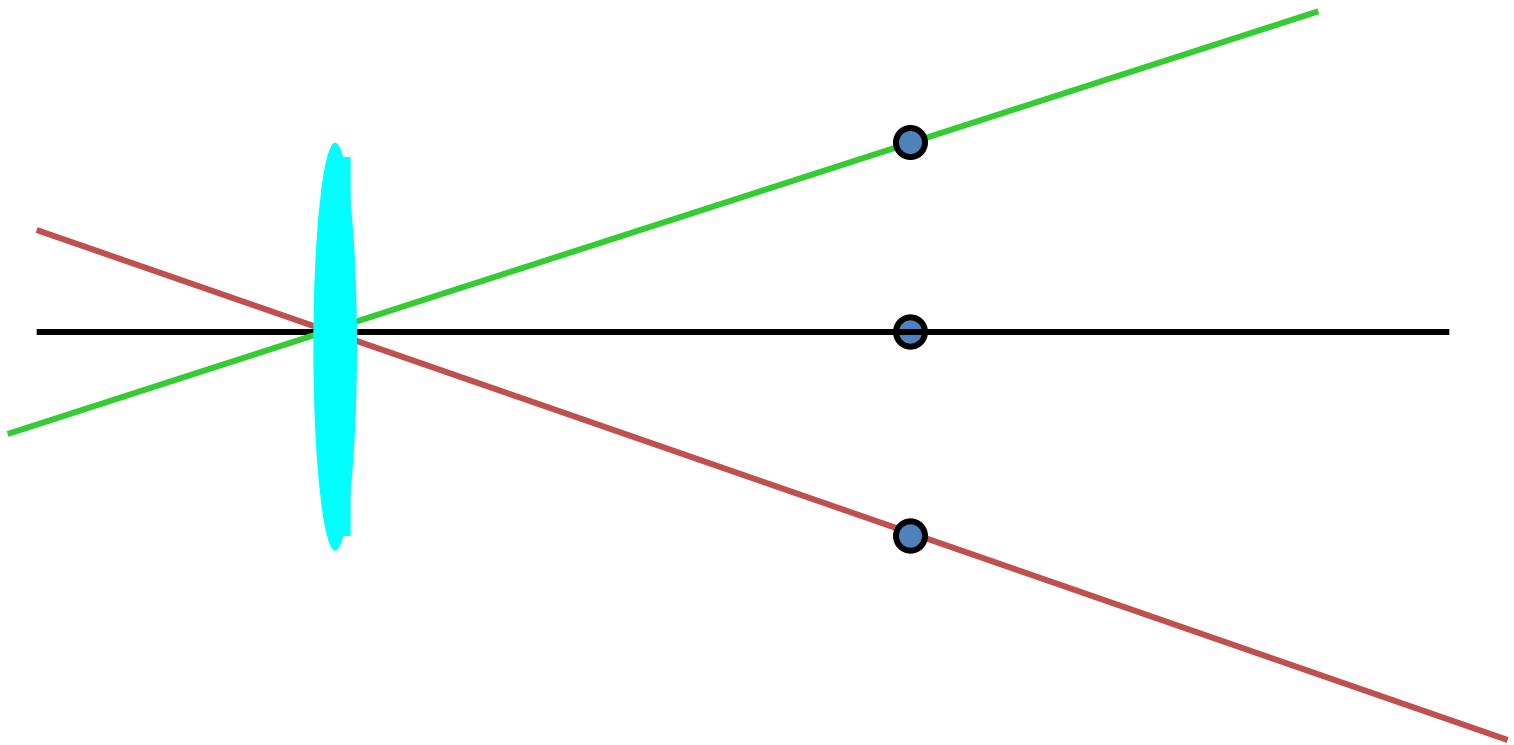

How to trace rays

- Start by rays through the center
- Choose focal length, trace parallels

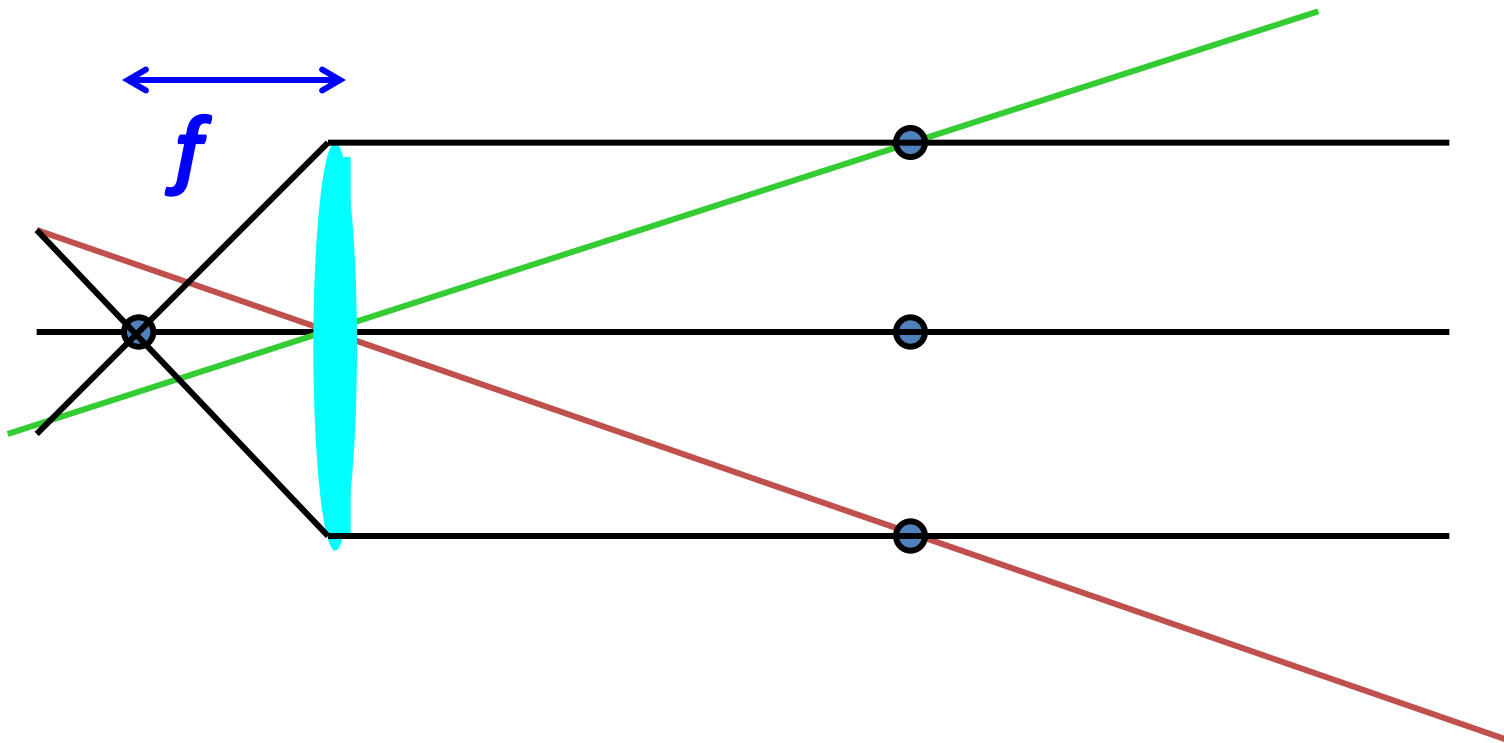

How to trace rays

- Start by rays through the center
- Choose focal length, trace parallels
- You get the focus plane for a given scene plane
 - All rays coming from points on a plane parallel to the lens are focused on another plane parallel to the lens

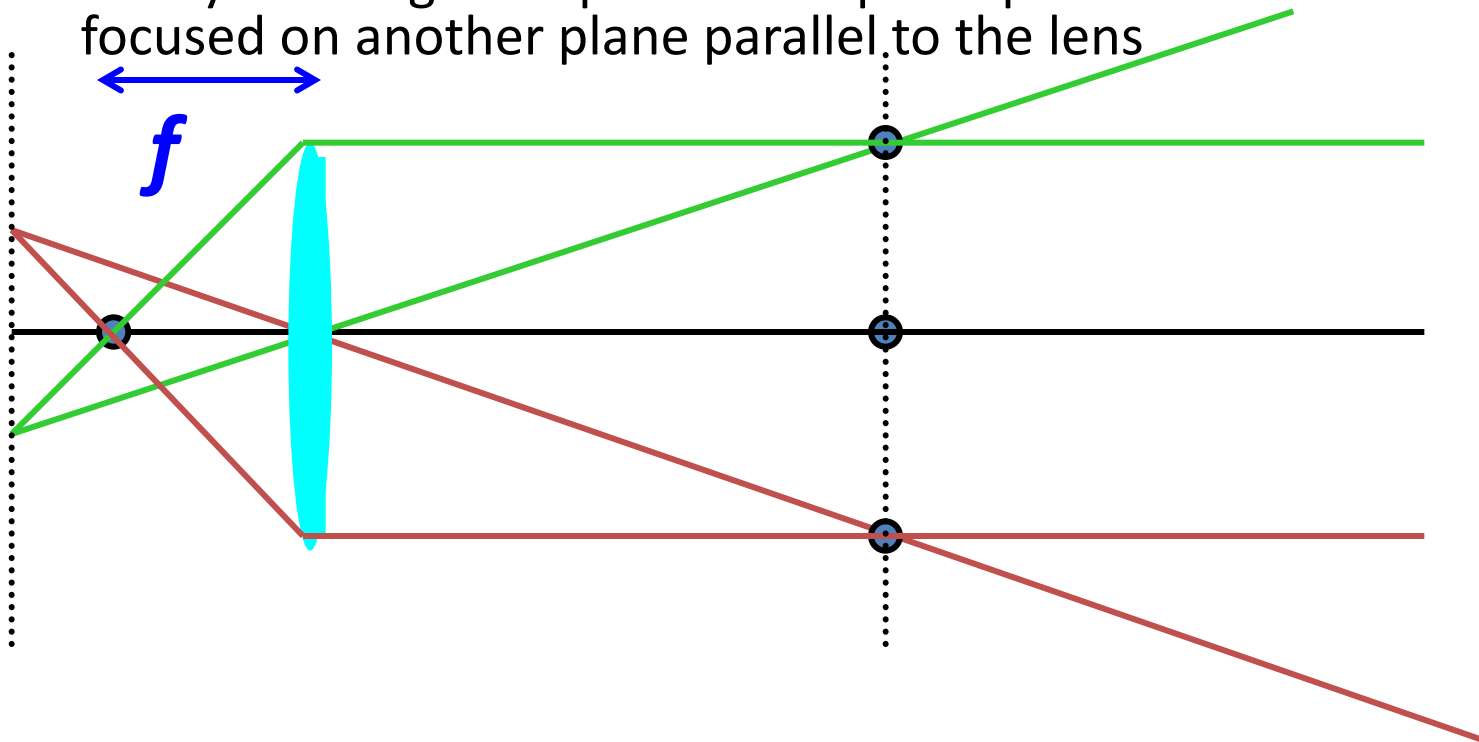

Focusing

- To focus closer than infinity
 - Move the sensor/film *further* than the focal length

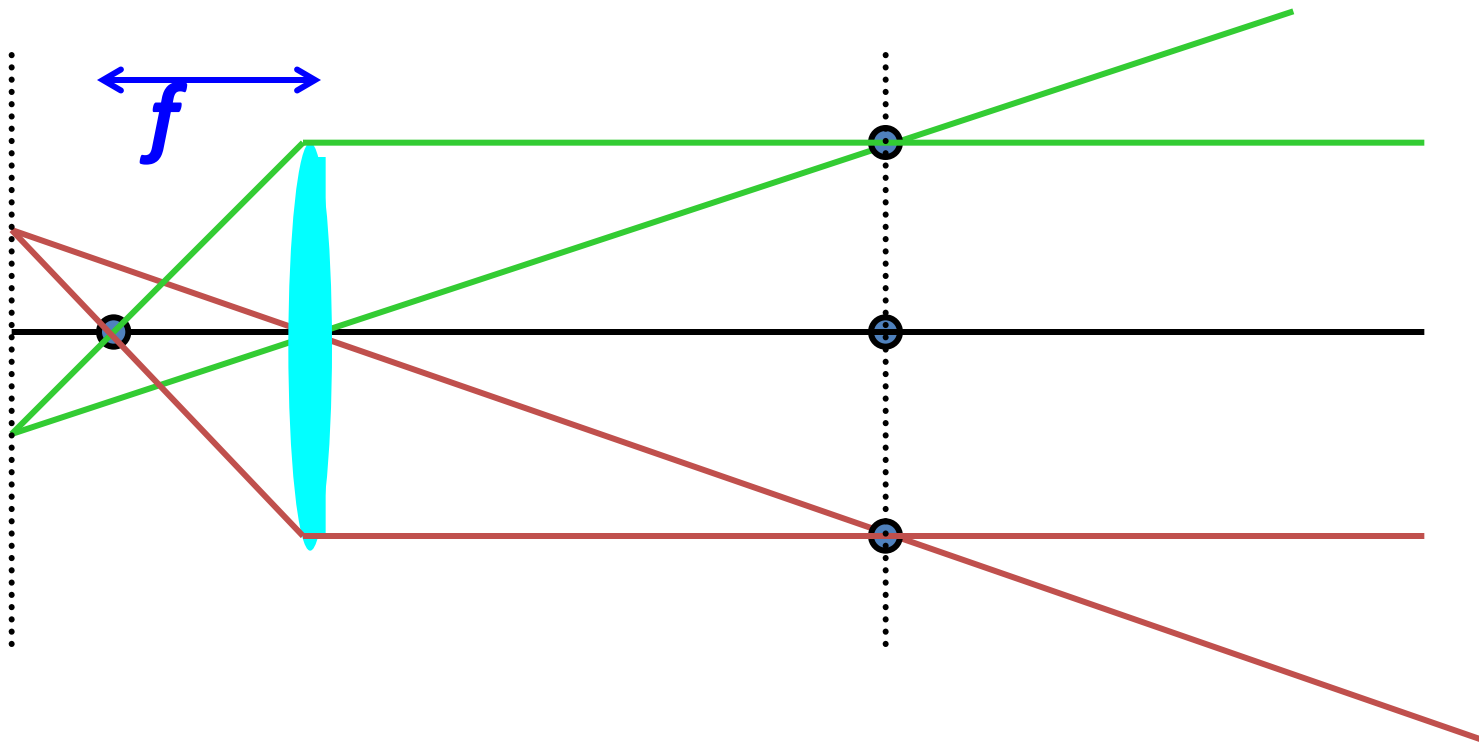

Thin lens formula

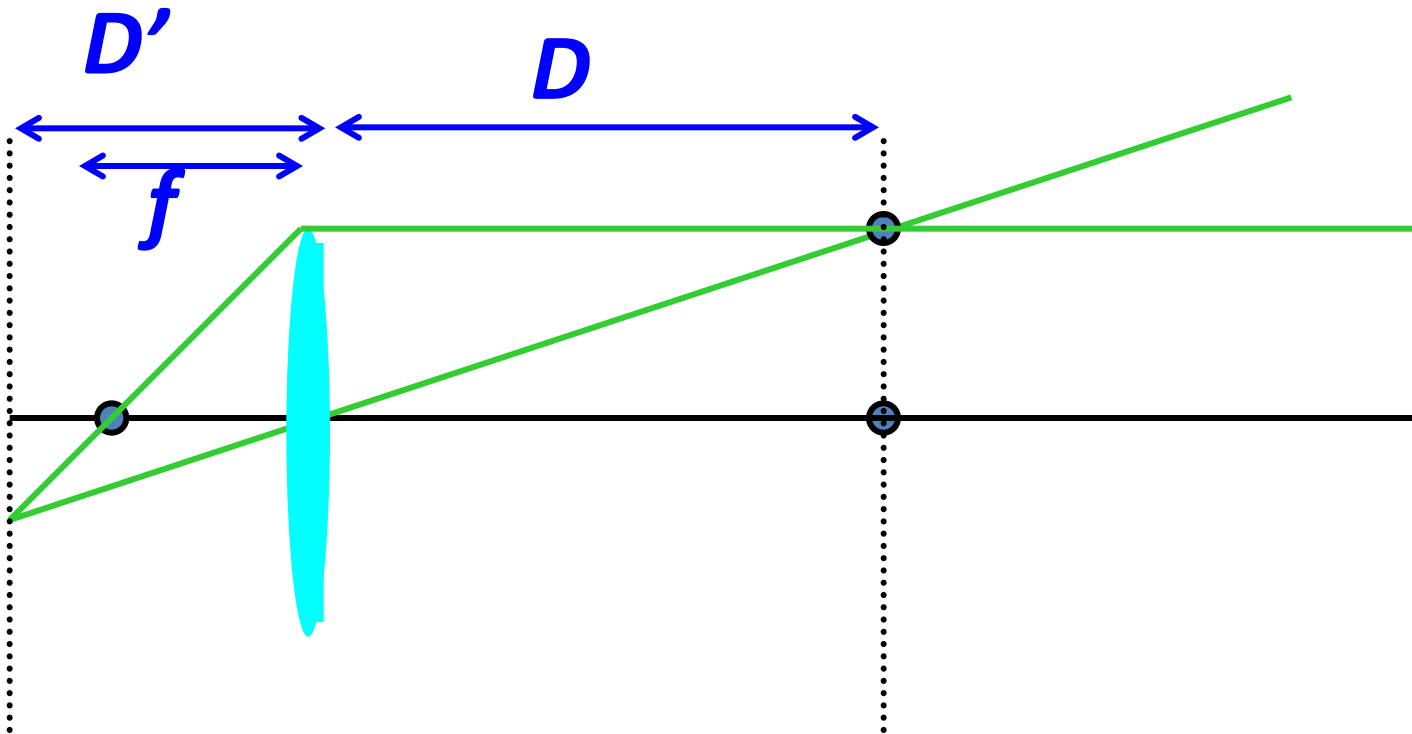

Thin lens formula

Similar triangles everywhere!

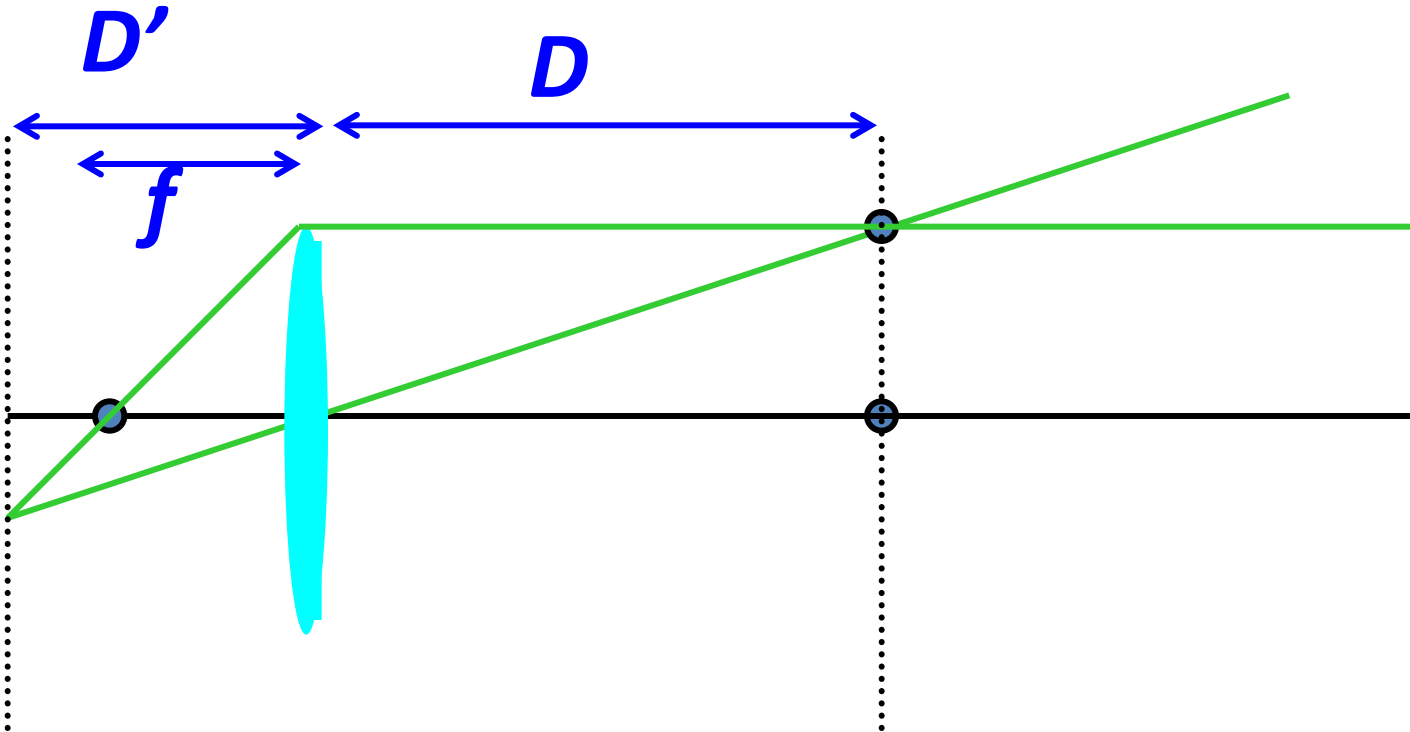

Thin lens formula

Similar triangles everywhere!

$$y'/y = D'/D$$

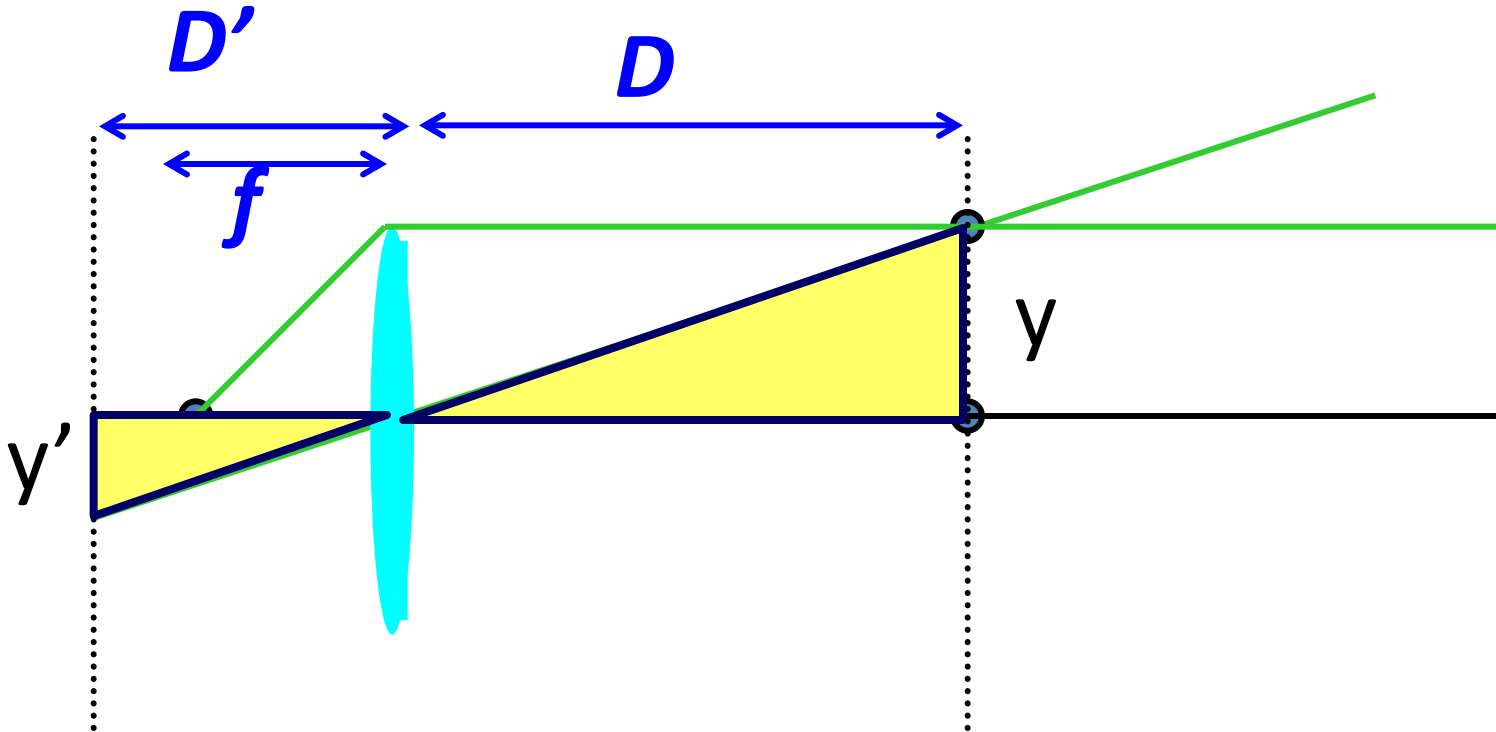

Thin lens formula

Similar triangles everywhere!

$$y'/y = D'/D$$

$$y'/y = (D' - f)/D$$

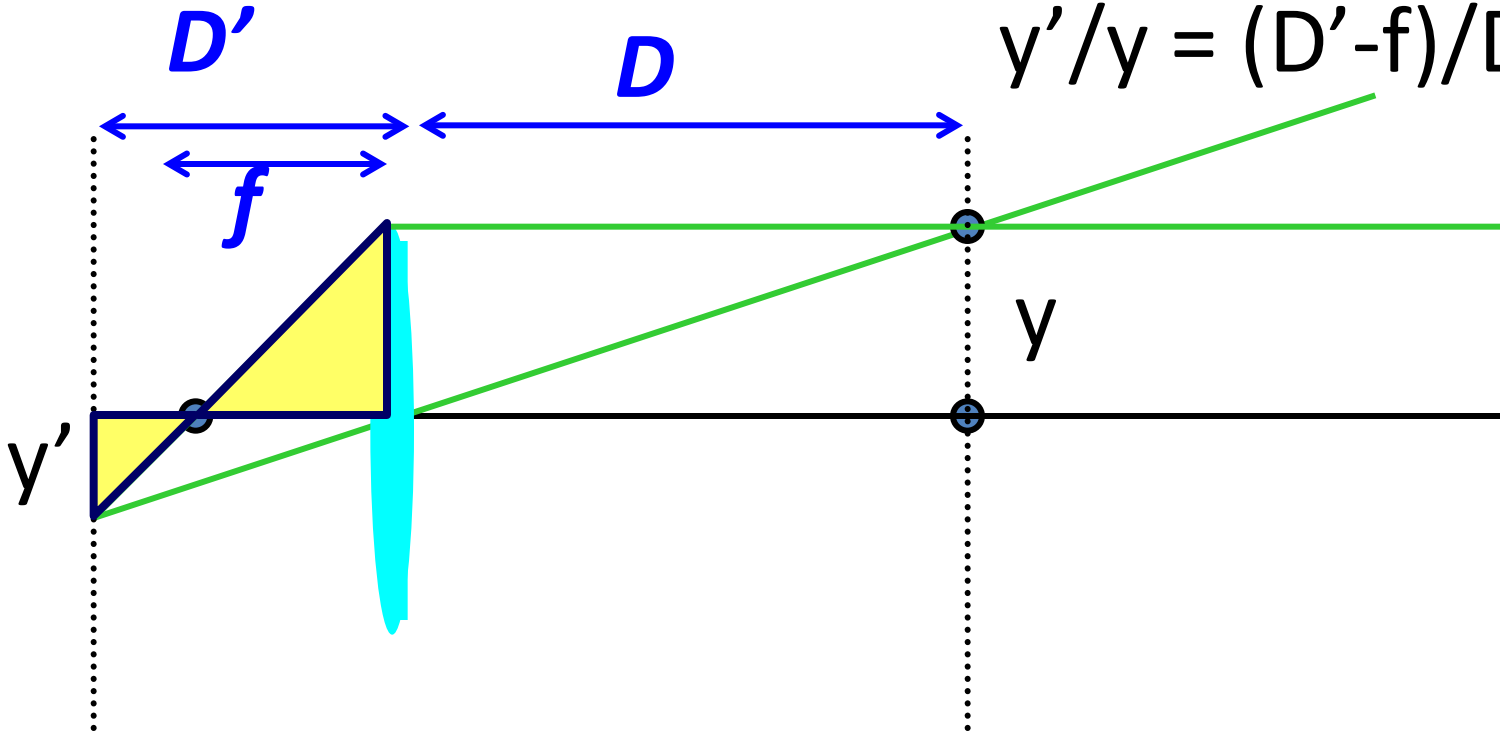

Thin lens formula

$$\frac{1}{D'} + \frac{1}{D} = \frac{1}{f}$$

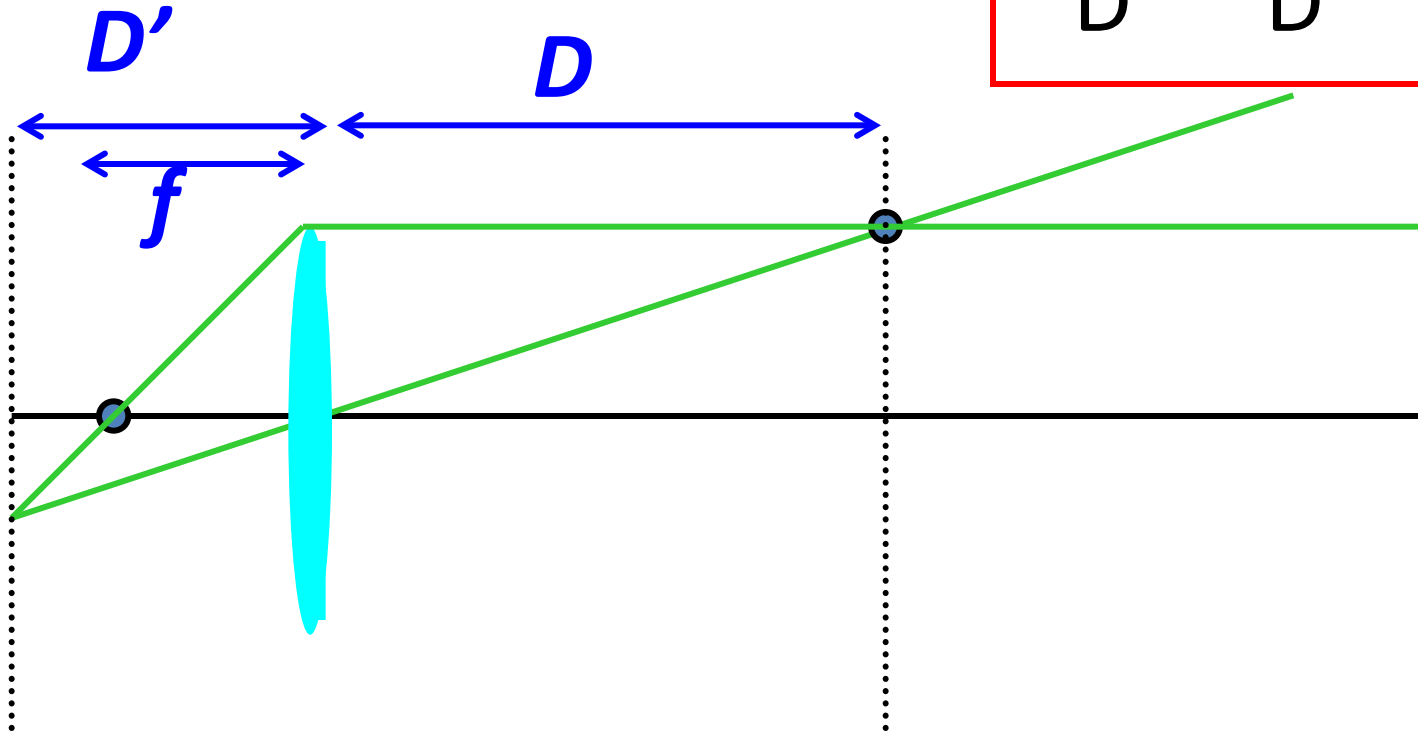

Minimum focusing distance

- By symmetry, an object at the focal length requires the film to be at infinity.

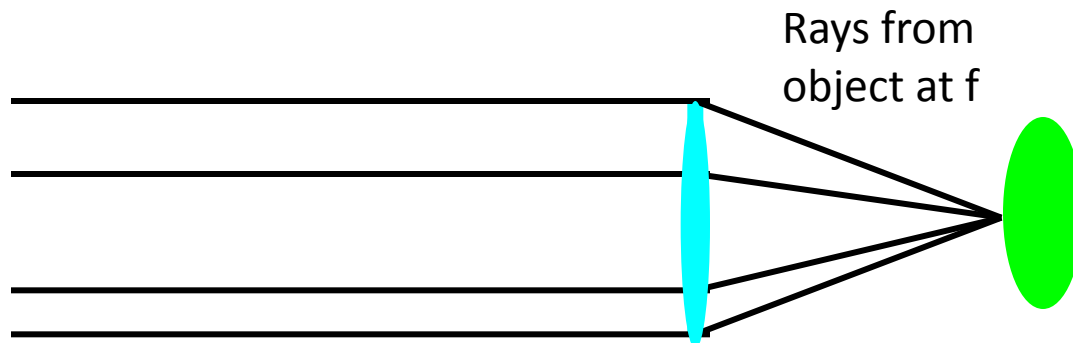
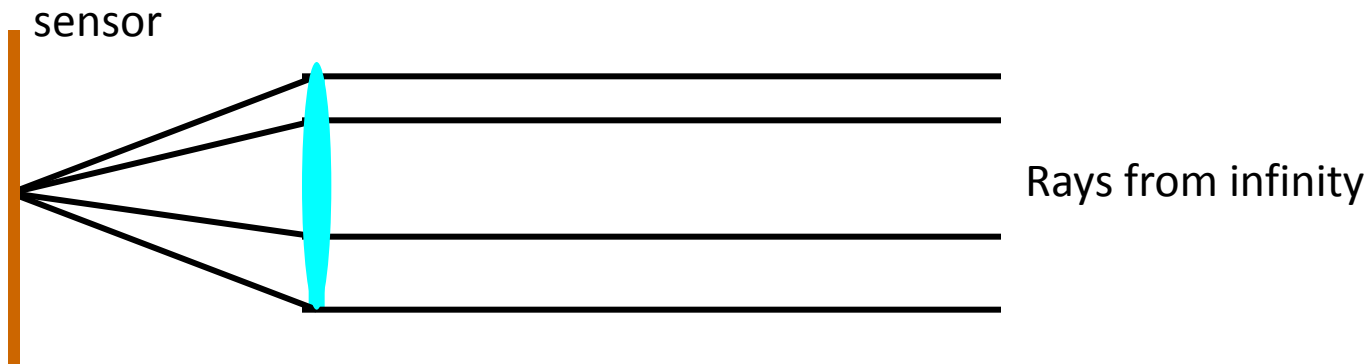

Extensions tubes

- Allow us to put sensor farther
 - focus closer

Field of view & focusing

- What happens to the field of view when one focuses closer?
 - It's reduced

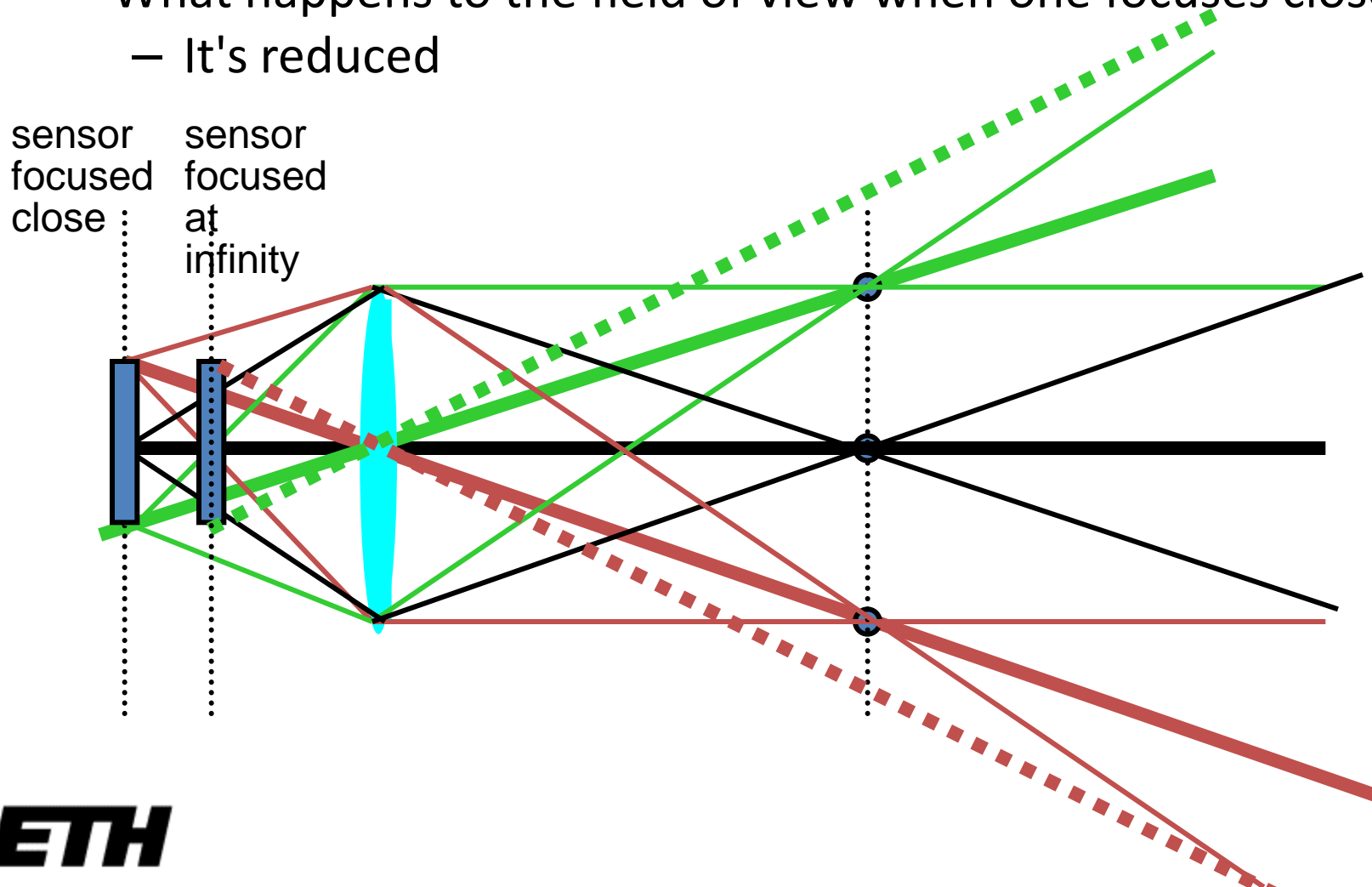

Focal length in practice

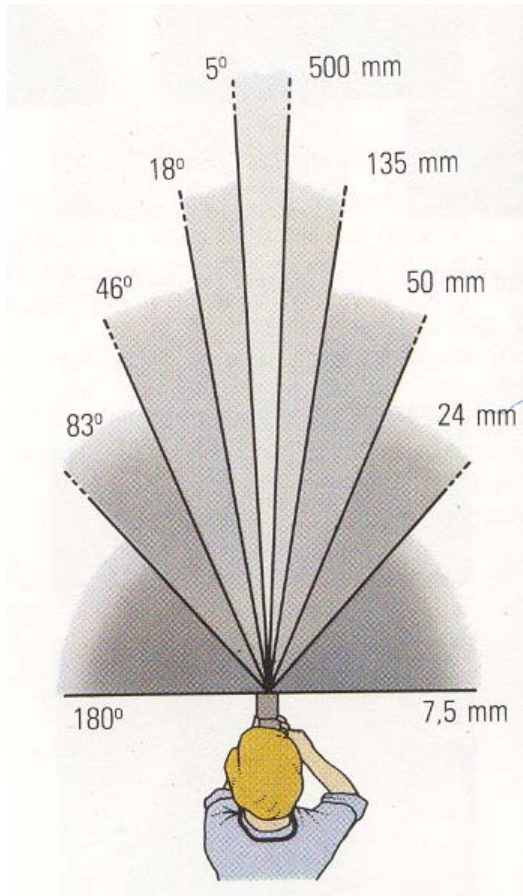

24mm

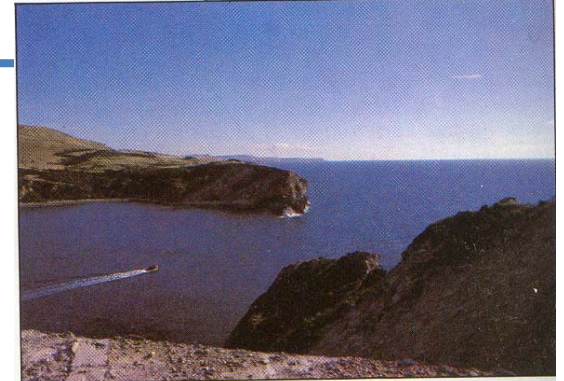

50mm

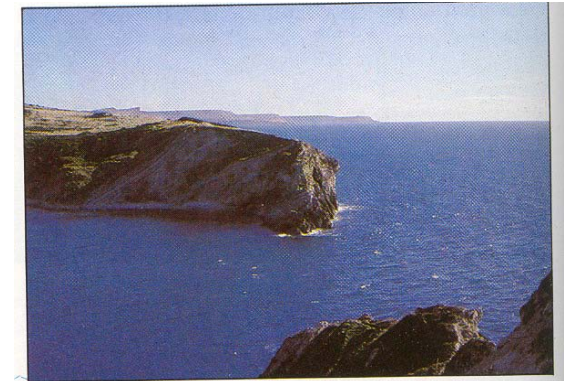

135mm



Perspective vs. viewpoint

- Telephoto makes it easier to select background (a small change in viewpoint is a big change in background).

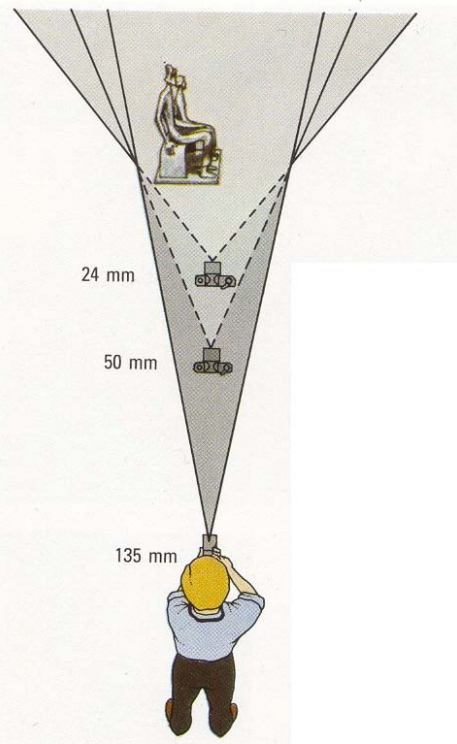

Grand-angulaire 24 mm



Normal 50 mm



Longue focale 135 mm

Perspective vs. viewpoint

- Moves camera as you zoom in
- Hitchcock Vertigo effect



Perspective vs. viewpoint

- Portrait: distortion with wide angle
- Why?



Wide angle



Standard



Telephoto

Focal length & sensor

- What happens when the film is half the size?
- Application:
 - Real film is 36x24mm
 - On the 20D, the sensor is 22.5 x 15.0 mm
 - Conversion factor on the 20D?
 - On the SD500, it is 1/1.8 " (7.18 x 5.32 mm)
 - What is the 7.7-23.1mm zoom on the SD500?

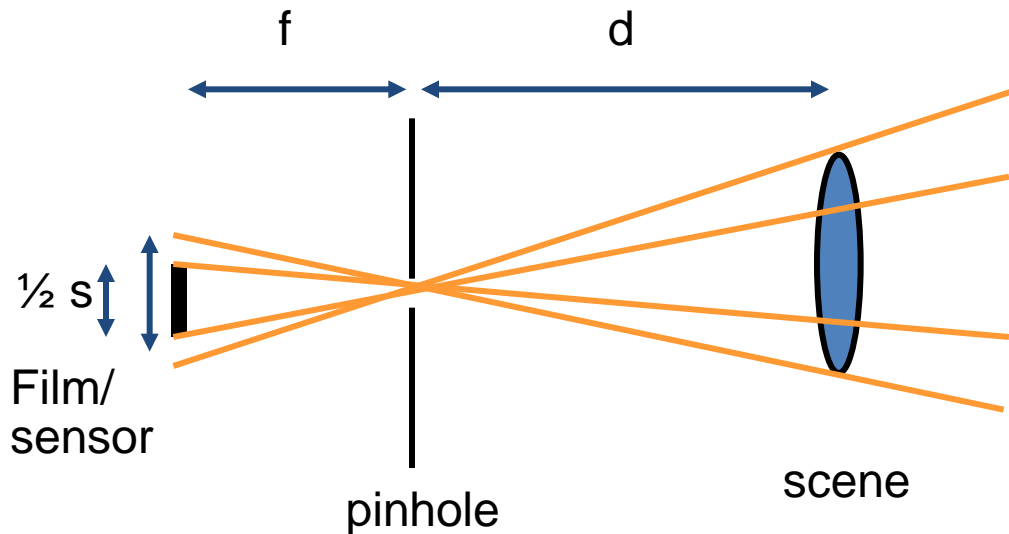

Sensor size



EOS-1Ds : 35.8 x 23.8mm



EOS-1D : 28.7 x 19.1mm



EOS 10D : 22.7 x 15.1mm

- Similar to cropping

35mm full size and digital shooting range image size (picture dimensions) and lens selection



— EOS-1Ds / — EOS-1D/ — EOS 10D

source: canon red book



EOS-1D



EOS 10D

(The EOS Kiss Digital/EOS DIGITAL Rebel/EOS 300D DIGITAL SLR camera has the same image size as the EOS 10D.)

36x24mm (35mm format)

28.7x19.1mm (EOS 1D) = 1.26x magnification factor

APS-C sized sensors (EOS 10D, Nikon D100, Pentax *ist D, etc) = 1.5x - 1.6x

18x13.5mm (4/3" system - Olympus E-1)

8.8x6.6mm (2/3" P&S)

8.8x6.6mm (2/3")

7.2x5.3mm (1/1.8")

5.3x4mm (1/2.7")

Recap

- Pinhole is the simplest model of image formation
- Lenses gather more light
 - But get only one plane focused
 - Focus by moving sensor/film
 - Cannot focus infinitely close
- Focal length determines field of view
 - From wide angle to telephoto
 - Depends on sensor size

More in the lens lecture

Questions?

Exposure

- Get the right amount of light to sensor/film
- Two main parameters:
 - Shutter speed
 - Aperture (area of lens)

Shutter speed

- Controls how long the film/sensor is exposed
- Pretty much linear effect on exposure
- Usually in fraction of a second:
 - 1/30, 1/60, 1/125, 1/250, 1/500
 - Get the pattern ?
- On a normal lens, normal humans can hand-hold down to 1/60
 - In general, the rule of thumb says that the limit is the inverse of focal length, e.g. 1/500 for a 500mm

Main effect of shutter speed

Slow shutter speed



Fast shutter speed



From Photography, London et al.

Effect of shutter speed

- Freezing motion

Walking people



1/125

Running people



1/250

Car



1/500

Fast train



1/1000

Shutter

- Various technologies

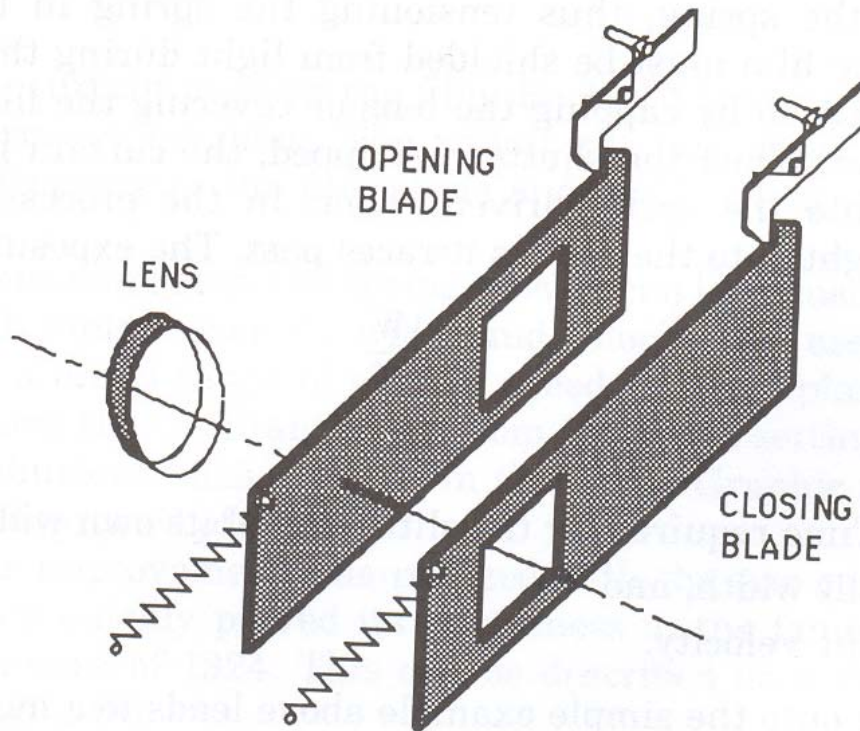

FIG. 2.8 Two-blade guillotine shutter.

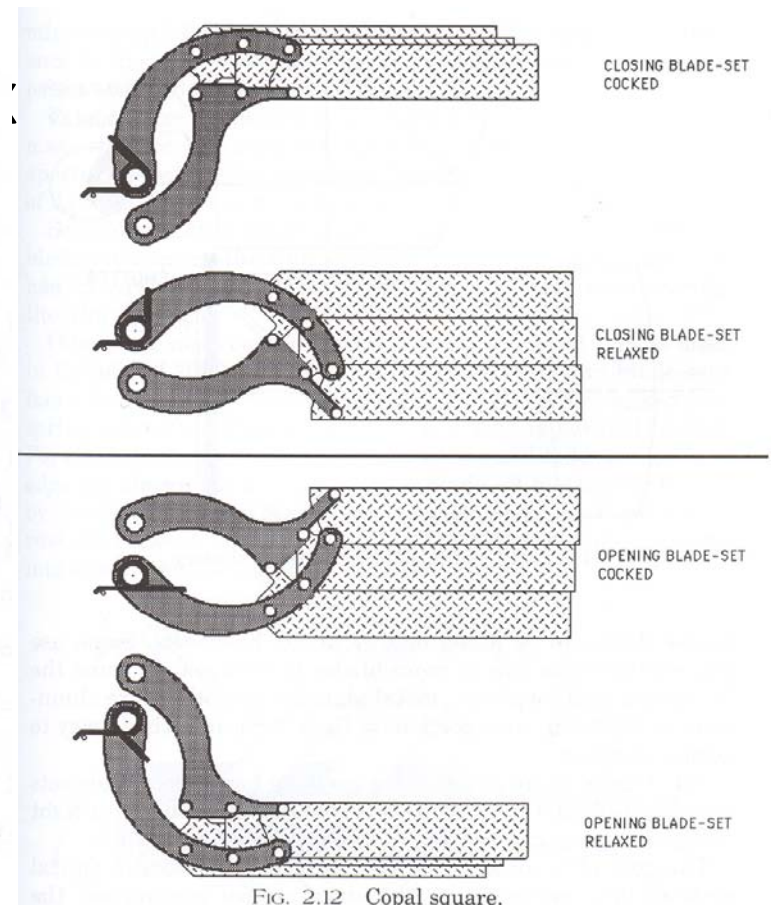

FIG. 2.12 Copal square.

Figure 6-6. Jacques Henri Lartigue, *Grand Prix of the Automobile Club of France, 1912*. This classic photograph provides an exaggerated example of the distortion that can be caused by a focal-plane shutter. The oval shape of the automobile tire is caused by the motion of the car between the time the bottom of the tire was exposed and the top. (Remember—the image is upside-down on the negative.) The same principle caused the leaning appearance of the spectators. Lartigue turned the camera to follow the automobile (panning), and thus the image of the spectators moved at the film plane during the exposure. (Courtesy International Museum of Photography at George Eastman House.)



Flash synch speed?

- Fastest shutter speed for which the shutter opens completely at some instant.
- For faster speeds, it opens and closes at the same time and exposes a slit.
- Modern high-speed flash synch uses multiple flash bursts

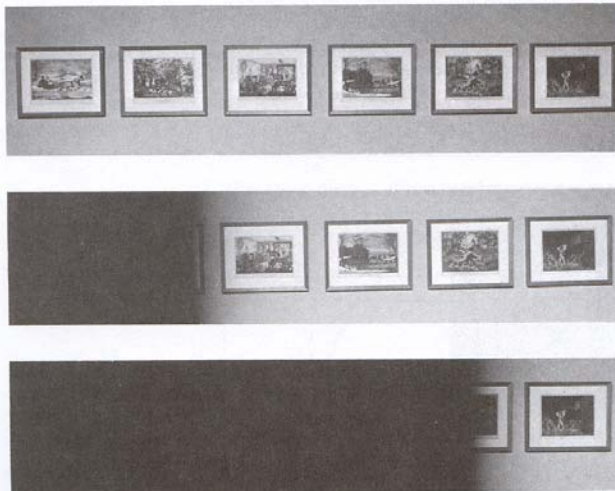
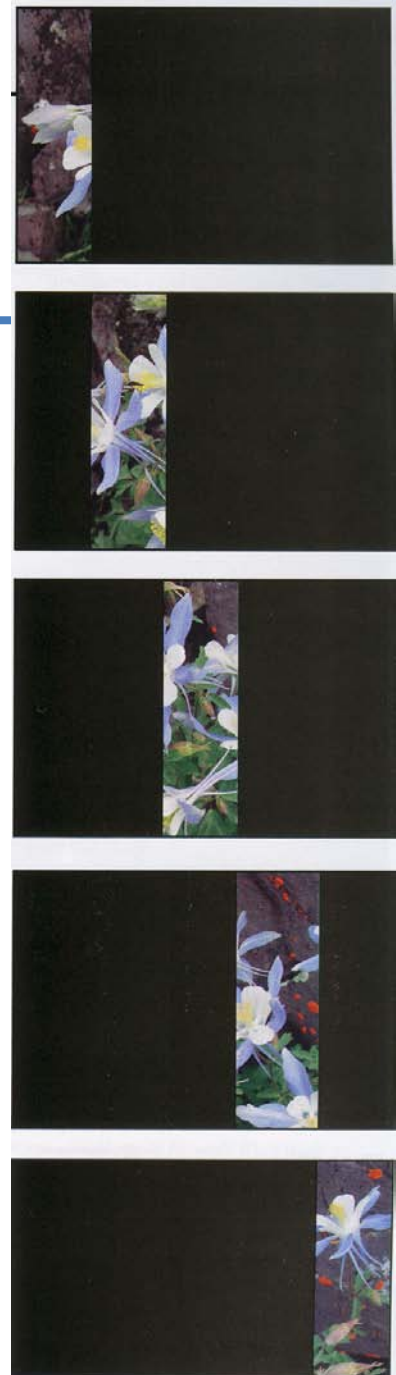

Figure 2-16 Electronic-flash illumination used with a focal-plane-shutter at shutter speeds of 1/60, 1/125, and 1/250 second (top to bottom). At the higher speeds the second curtain begins to cover the film before the first curtain has completely uncovered it. The highest shutter speeds that can be used with electronic flash have increased dramatically with newer single-lens-reflex cameras and flash units.



Aperture

- Diameter of the lens opening (controlled by diaphragm)
- Expressed as a fraction of focal length, in f-number
 - $f/2.0$ on a 50mm means that the aperture is 25mm
 - $f/2.0$ on a 100mm means that the aperture is 50mm
- Disconcerting: small f number = big aperture
- What happens to the area of the aperture when going from $f/2.0$ to $f/4.0$?
- Typical f numbers are $f/2.0$, $f/2.8$, $f/4$, $f/5.6$, $f/8$, $f/11$, $f/16$, $f/22$, $f/32$
 - See the pattern?



Full aperture



Medium aperture

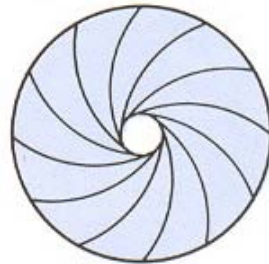

Stopped down

Main effect of aperture

Depth of field

Large aperture opening

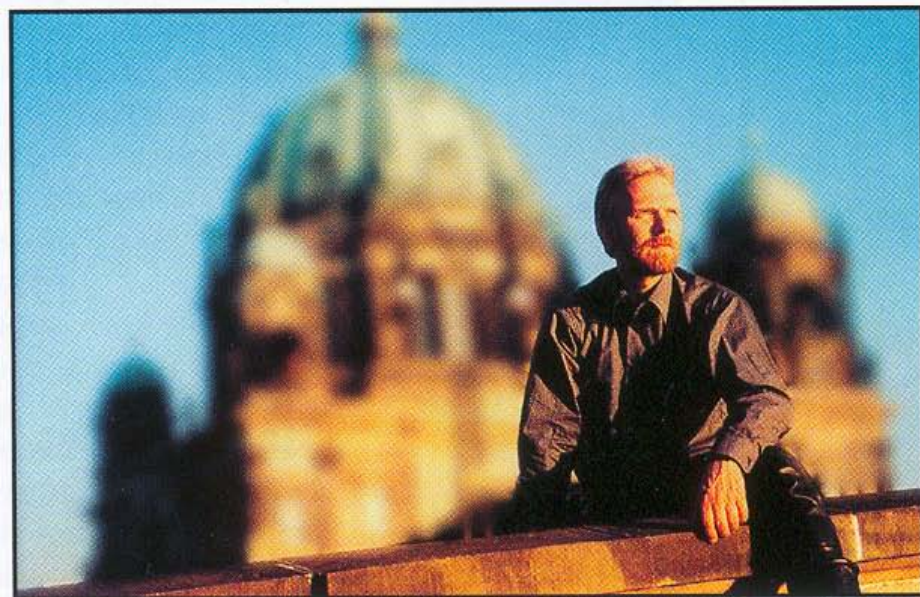

Small aperture opening

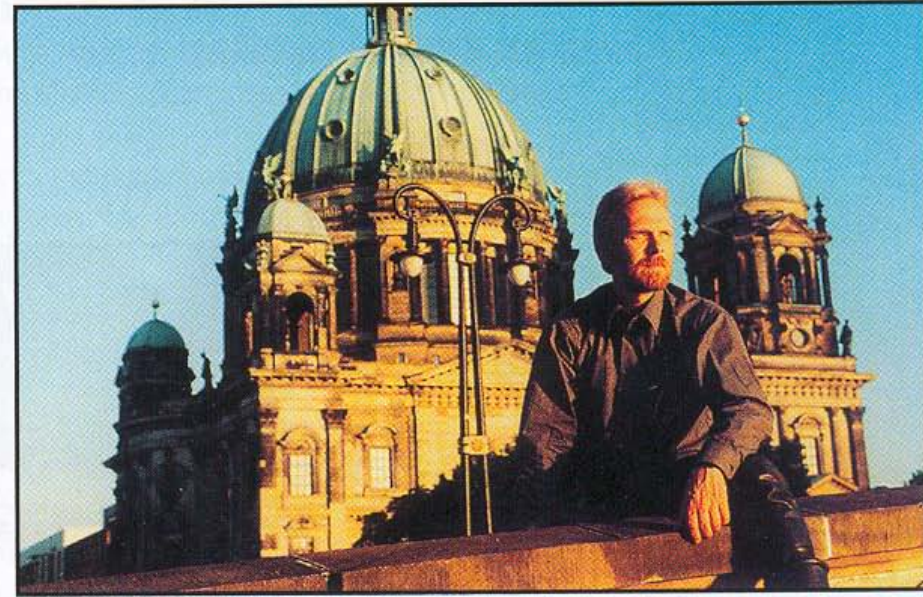

Depth of field

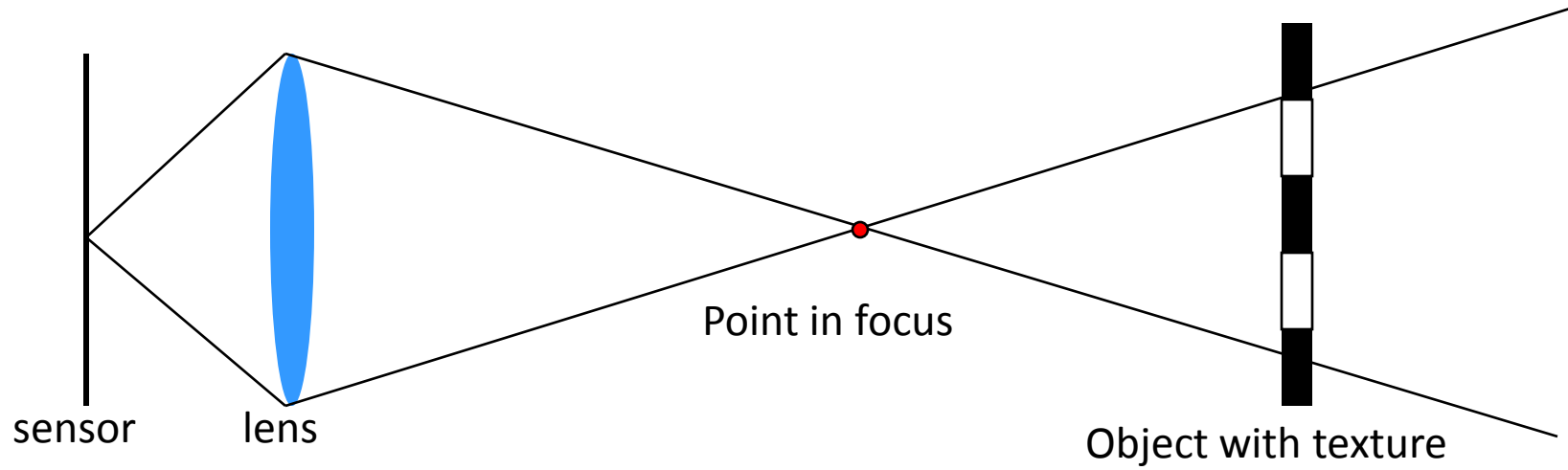

Depth of field

- We allow for some tolerance

Depth of field

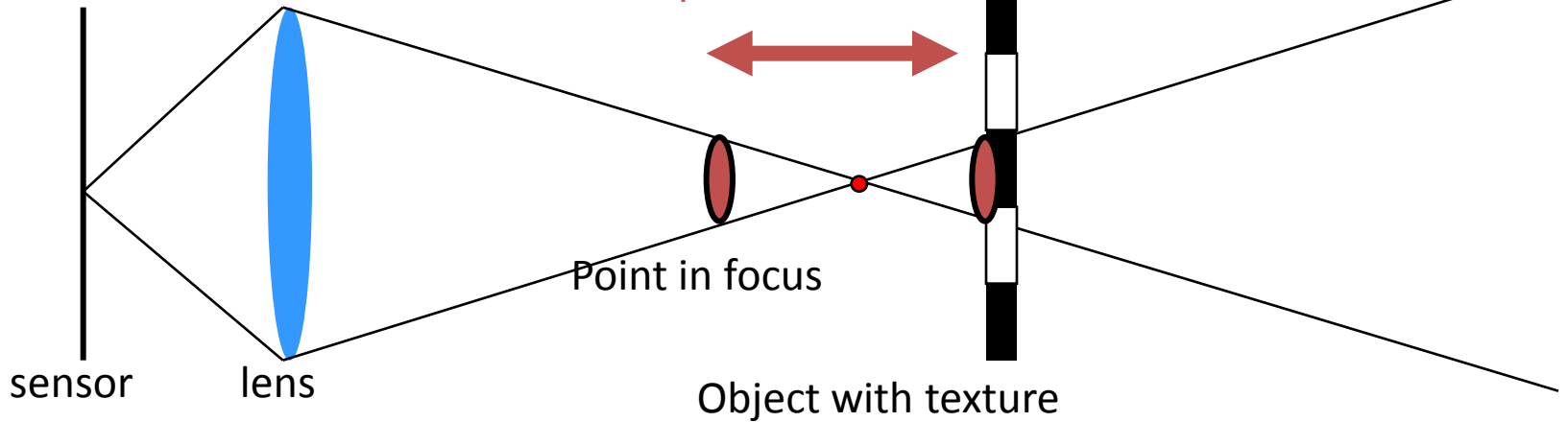

Depth of focus

Max acceptable circle of confusion

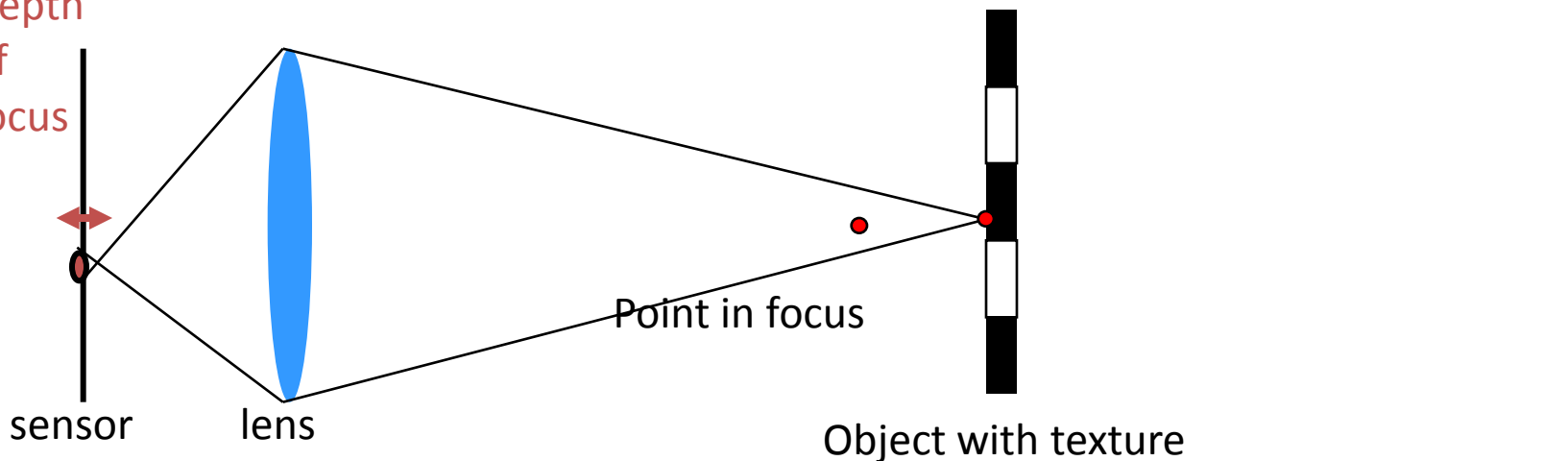

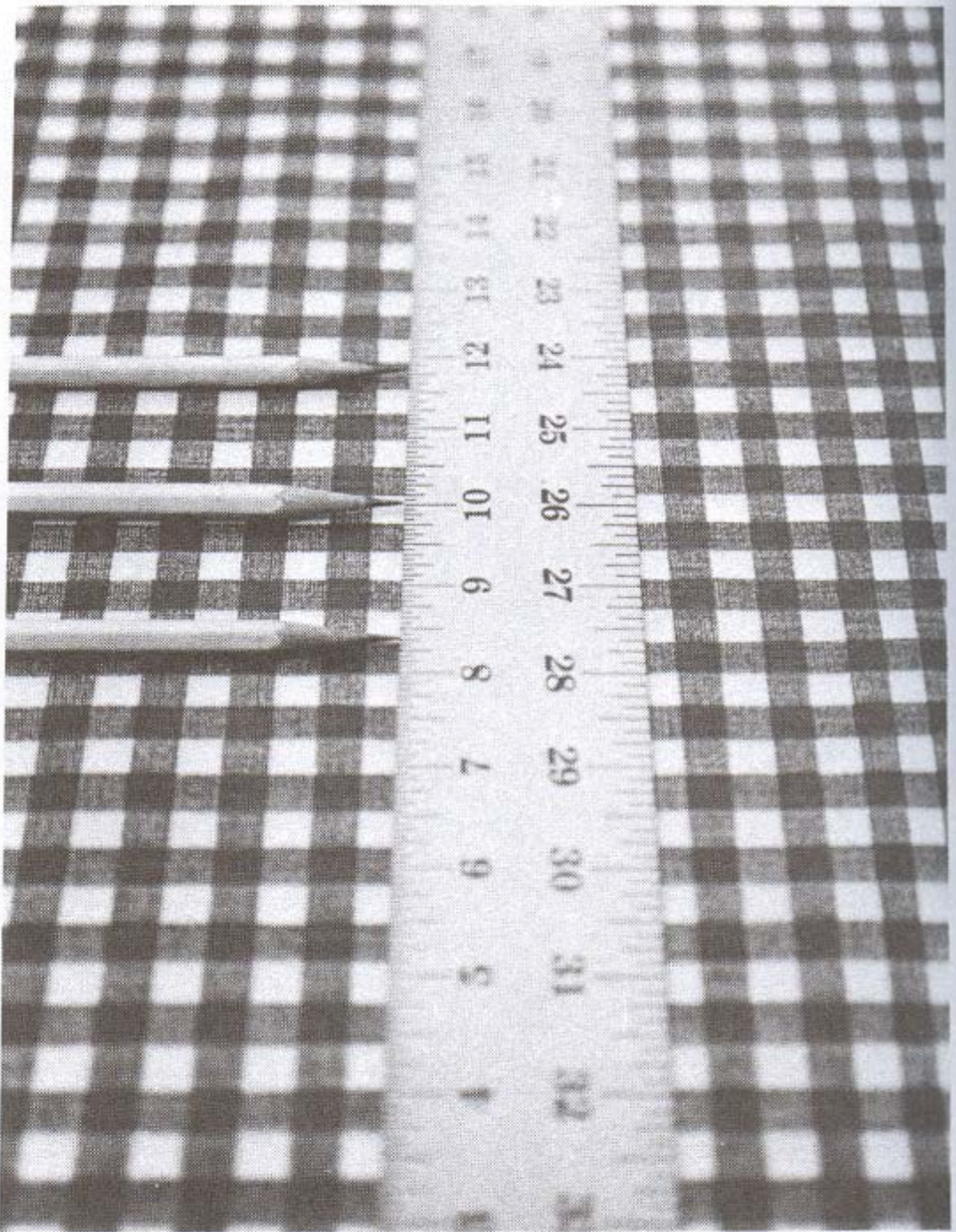

Depth of field

- What happens when we close the aperture by two stop?
 - Aperture diameter is divided by two
 - Depth of field is doubled

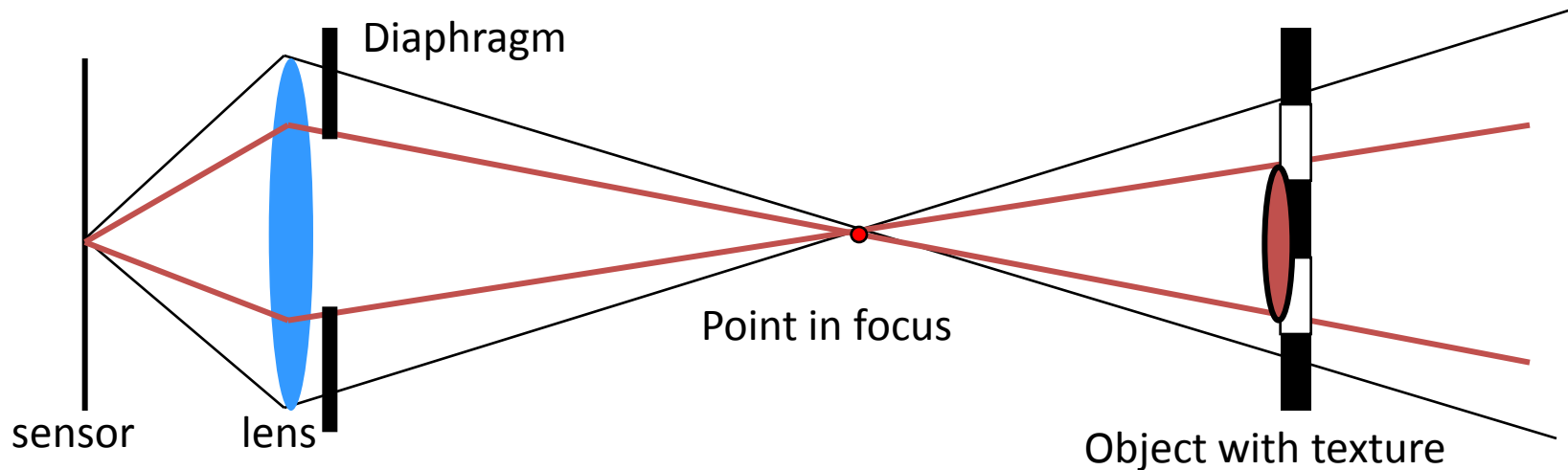

Depth of field

LESS DEPTH OF FIELD

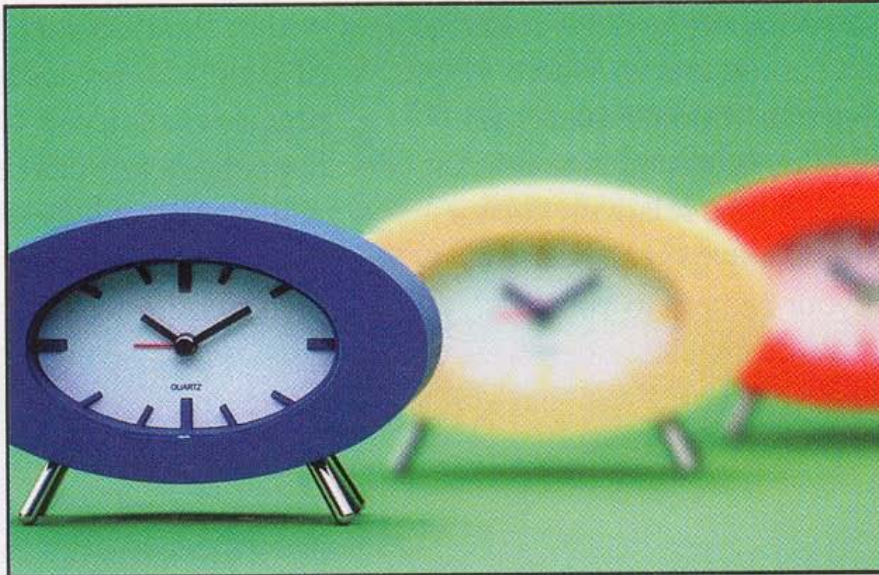

Wider aperture



f/2

MORE DEPTH OF FIELD

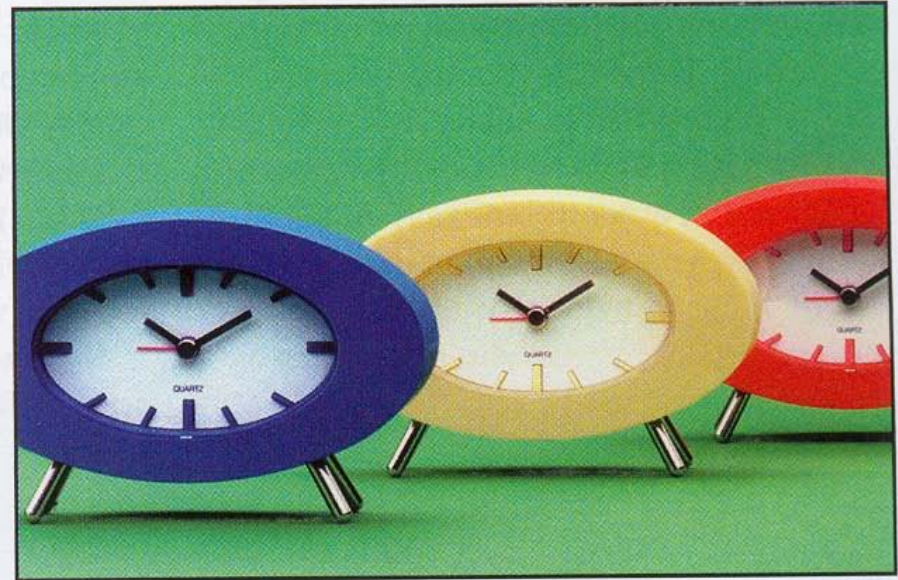

Smaller aperture



f/16

Depth of field & focusing distance

- What happens when we divide focusing distance by two?
 - Similar triangles => divided by two as well

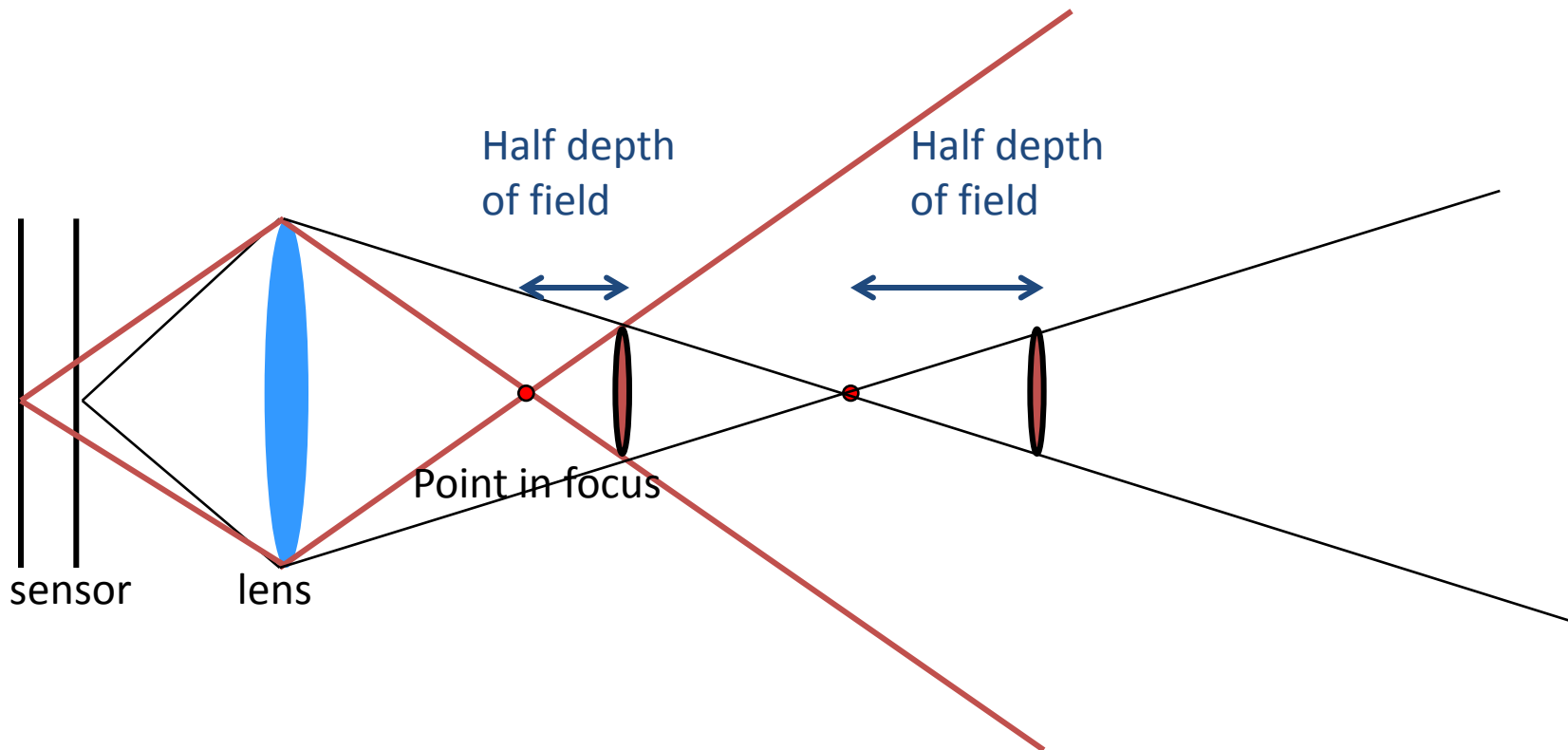

Depth of field & focusing distance

- What happens when we divide focusing distance by two?
 - Similar triangles => divided by two as well

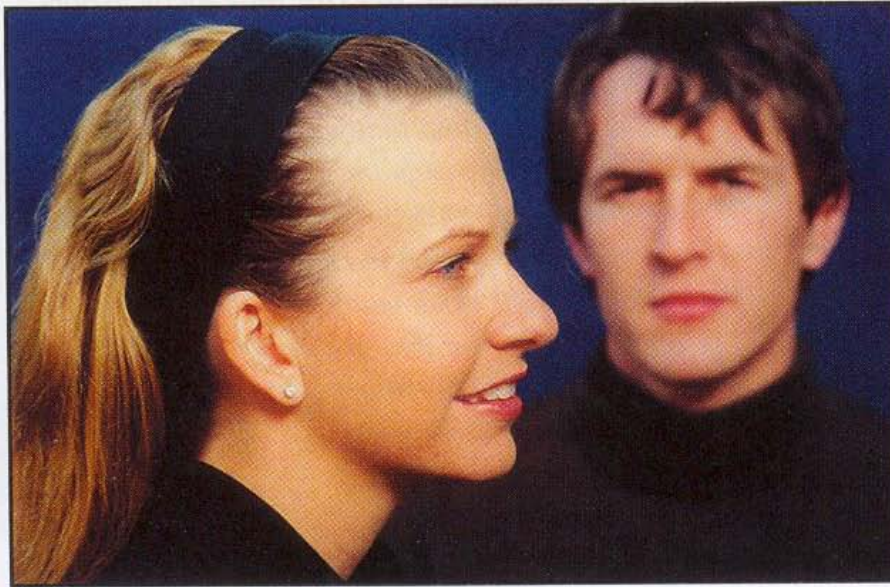

Closer to subject



3 feet



Farther from subject



10 feet

SLR viewfinder & aperture

- By default, an SLR always shows you the biggest aperture
- Brighter image
- Shallow depth of field help judge focus
- Depth of field preview button:
 - Stops down to the aperture you have chosen
 - Darker image
 - Larger depth of field

Questions?

Exposure

- Two main parameters:
 - Aperture (in f stop)
 - Shutter speed (in fraction of a second)

- Reciprocity

The same exposure is obtained with an exposure twice as long and an aperture *area* half as big

- Hence square root of two progression of f stops vs. power of two progression of shutter speed
- Reciprocity can fail for very long exposures

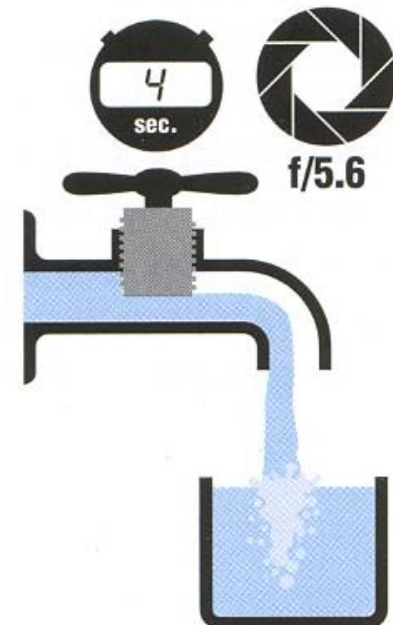
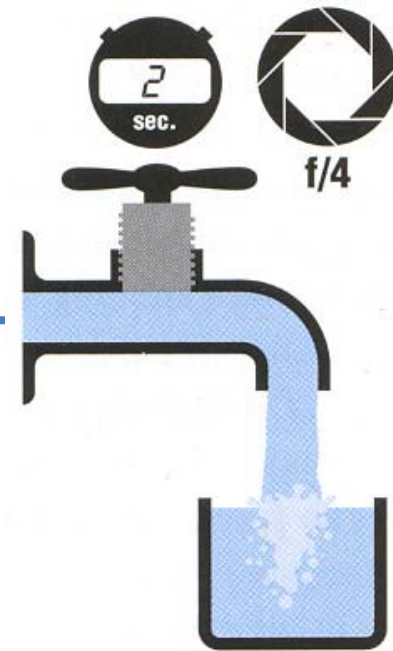

Reciprocity

- Assume we know how much light we need
- We have the choice speed/aperture pair

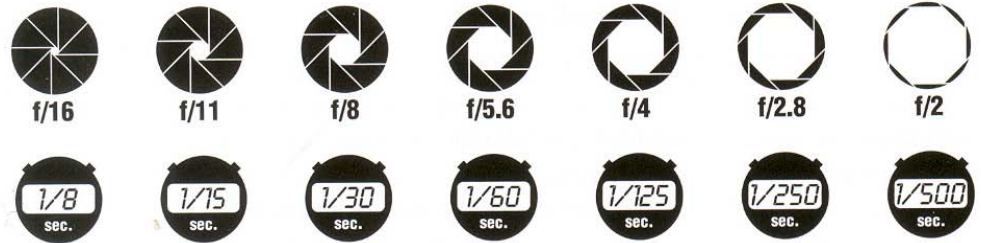

- What will guide our choice of a shutter speed?
 - Freeze motion vs. motion blur, camera shake
- What will guide our choice of an aperture?
 - Depth of field, diffraction limit
- Often we must compromise
 - Open more to enable faster speed (but shallow DoF)

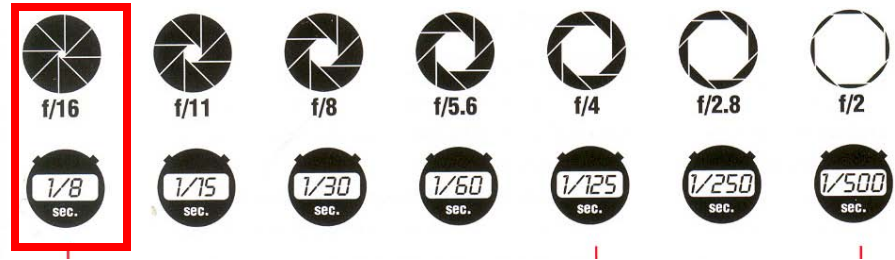

Small aperture (deep depth of field), slow shutter speed (motion blurred). In this scene, a small aperture ($f/16$) produced great depth of field; the nearest paving stones as well as the farthest trees are sharp. But to admit enough light, a slow shutter speed ($1/8$ sec) was needed; it was too slow to show moving pigeons sharp. It also meant that a tripod had to be used to hold the camera steady.

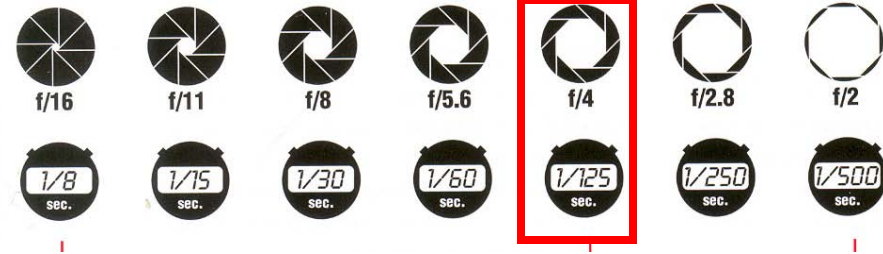
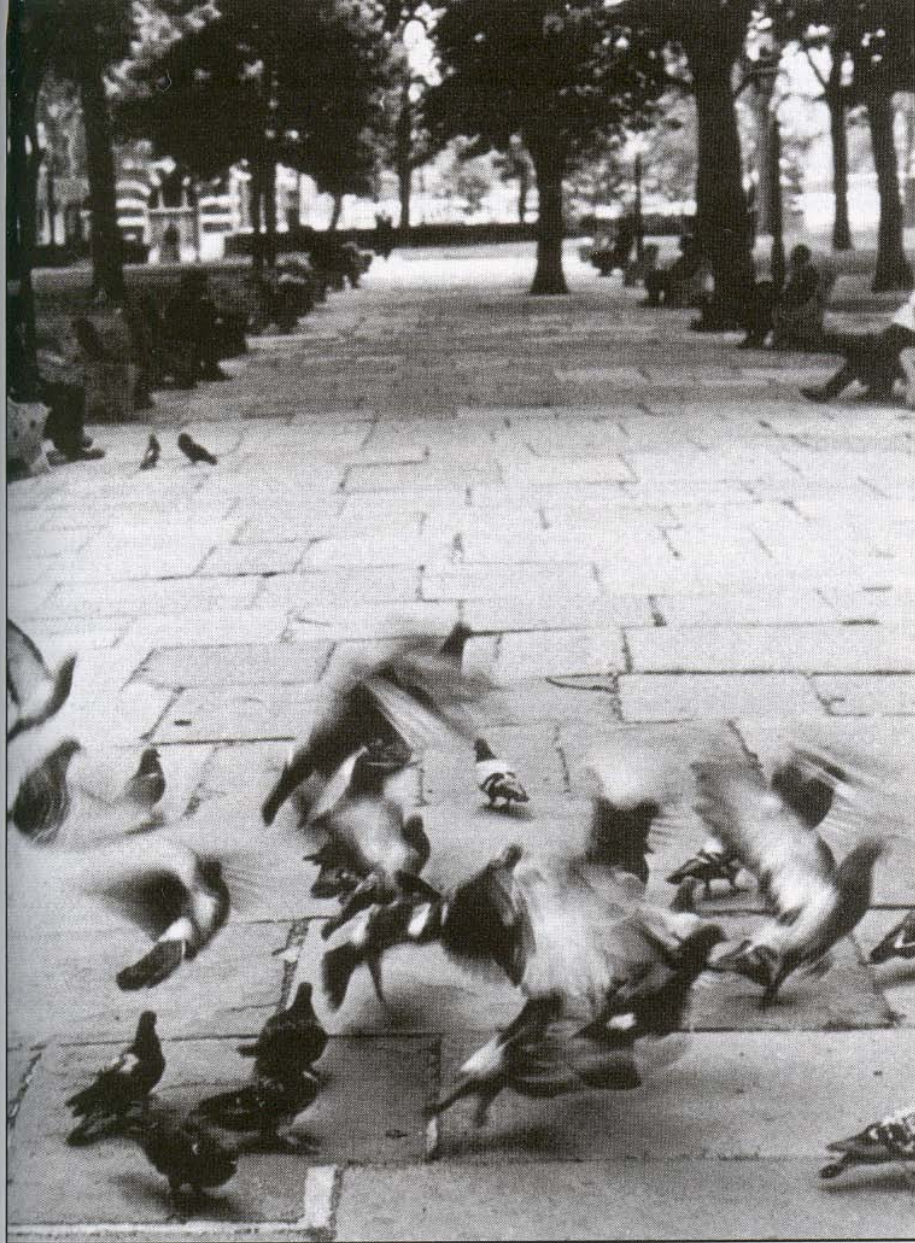

Medium aperture (moderate depth of field), medium shutter speed (some motion sharp). A medium aperture ($f/4$) and shutter speed ($1/125$ sec) sacrifice some background detail to produce recognizable images of the birds. But the exposure is still too long to show the motion of the birds' wings sharply.

From Photography, London et al.

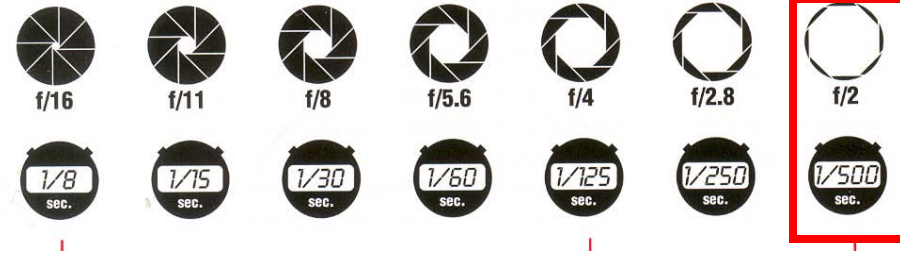

Large aperture (shallow depth of field), fast shutter speed (motion sharp). A fast shutter speed (1/500 sec) stops the motion of the pigeons so completely that the flapping wings are frozen. But the wide aperture (f/2) needed gives so little depth of field that the background is now out of focus.

From Photography, London et al.

Questions?

Metering

- Photosensitive sensors measure scene luminance
- Usually TTL (through the lens)
- Simple version: center-weighted average

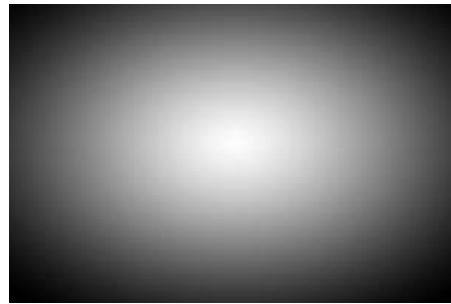

- Assumption? Failure cases?
 - Usually assumes that a scene is 18% gray
 - Problem with dark and bright scenes



White polar bear given exposure suggested by meter



White polar bear given 2 stops more exposure



Gray elephant given exposure suggested by meter



Black gorilla given exposure suggested by meter



Black gorilla given 2 stops less exposure

Metering

- Centered average
- Spot
- Smart metering
 - Nikon 3D matrix
 - Canon evaluative
- Incident
 - Measure incoming light

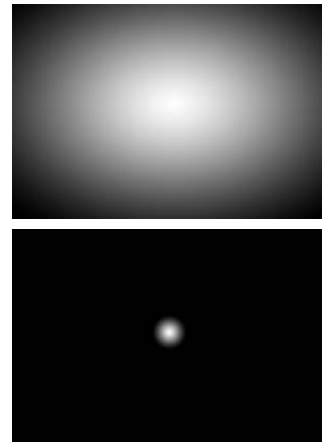

Next slide

Choice on Nikon



<http://www.mir.com.my//>



From the luminous landscape

Nikon 3D Color Matrix

<http://www.mir.com.my/rb/photography/hardwares/classics/NikonF5/metering/>

- Learning from database of 30,000 photos
- Multiple captors (segments)
- Exposure depends on
 - Brightness from each segments
 - Color
 - Contrast
 - Distance
 - Focus (where is the subject)

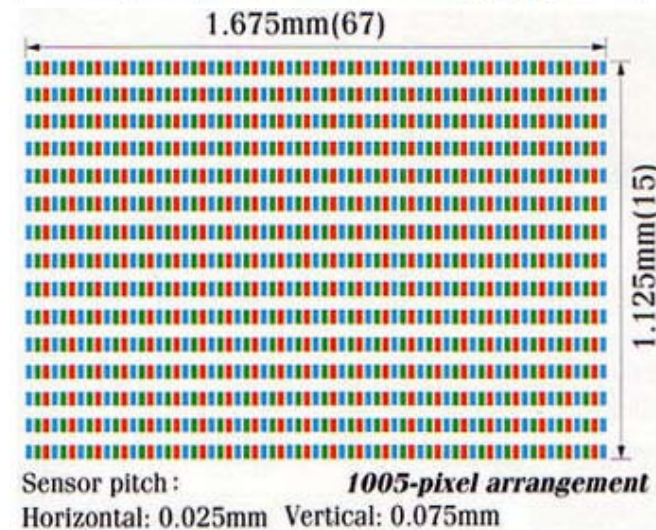
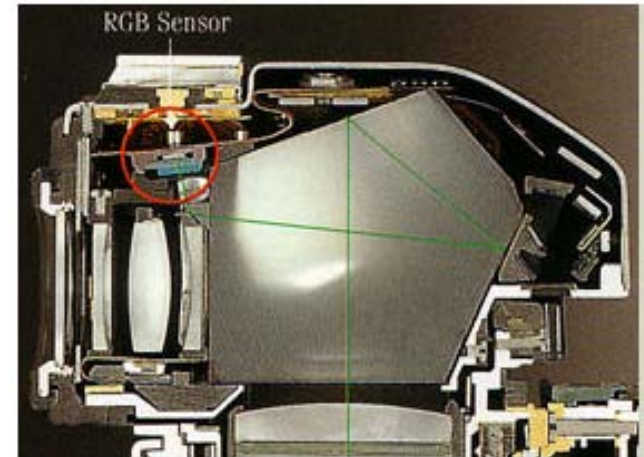

Exposure & metering

- The camera metering system measures how bright the scene is
- In Aperture priority mode, the photographer sets the aperture, the camera sets the shutter speed
- In Shutter-speed priority mode, the photographers sets the shutter speed and the camera deduces the aperture
 - In both cases, reciprocity is exploited
- In Program mode, the camera decides both exposure and shutter speed (middle value more or less)
- In Manual, the user decides everything (but can get feedback)

Pros and cons of various modes

- Aperture priority
 - Direct depth of field control
 - Cons: can require impossible shutter speed (e.g. with f/1.4 for a bright scene)
- Shutter speed priority
 - Direct motion blur control
 - Cons: can require impossible aperture (e.g. when requesting a 1/1000 speed for a dark scene)
 - Note that aperture is somewhat more restricted
- Program
 - Almost no control, but no need for neurons
- Manual
 - Full control, but takes more time and thinking

Recap: Metering

- Measure scene brightness
- Some advanced modes that take multiple sources of information
- Still an open problem

Questions?

Sensitivity (ISO)

- Third variable for exposure
- Linear effect (200 ISO needs half the light as 100 ISO)
- Film photography: trade sensitivity for grain



Kodachrome 25 ASA



Ektachrome 64 ASA



Fujichrome 100 ASA



Ektachrome 200 ASA

From dpreview.com

